



EDNA P5

IN-32ZK88/028/z3*

WWW.OSMONT.CZ

EDNA P5

Product code: EDN54113

Type: IN-32ZK88/028/z3*

Short description of the luminaire: White pendant E27 light ON/OFF with TRIPLEX OPAL glass shade.



Technical

Types of luminaires	Classic on/off
Mounting type	Suspended - rod
Base material	steel
Shade material	three-layer glass TRIPLEX OPAL
Base color	white Ral9003
Shade color	white
Holding the shade	folding system
Mounting location	ceiling
Width	490 mm
Length	490 mm
Height	130 mm
Diameter	ø 490 mm
Hinge length	600 mm
mounting holes (diameter)	2xø5mm
Installation wire (diameter)	2xø16mm
Impact strength	IK01
Operating temperature	from -20°C to +30°C

Electric

Voltage type	AC
AC voltage	220 - 240 V
Power consumption	3x25 W
Ingress Protection	IP40
Socket	E27
terminal block	screw terminal block

Luminous

Blue light hazard	Risk group 0
-------------------	--------------

Eulum data for calculation programs are available at www.osmont.cz.

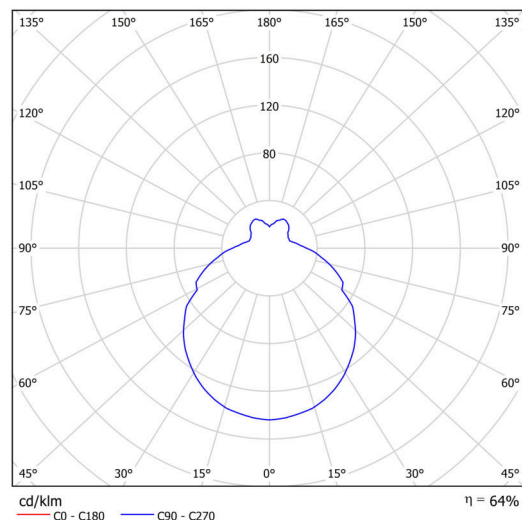
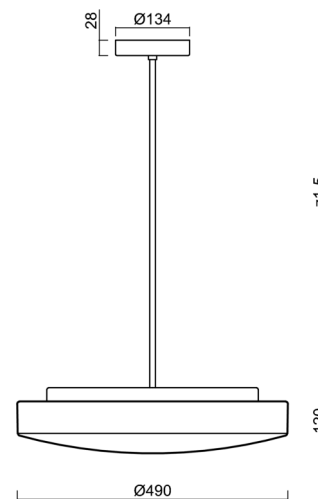

Logistic

EAN	8591728541132
Weight NTTO	5.1 Kg
Weight BTTO	6.9 Kg
Number of cartons	2 pcs
Package volume	0.057 m ³
Package 1 width	0.515 m
Package 1 length	0.495 m
Package 1 height	0.14 m
Warranty*	60 months

*The warranty for the batteries is valid for 12 months from the date of purchase.

Installation dimensions:

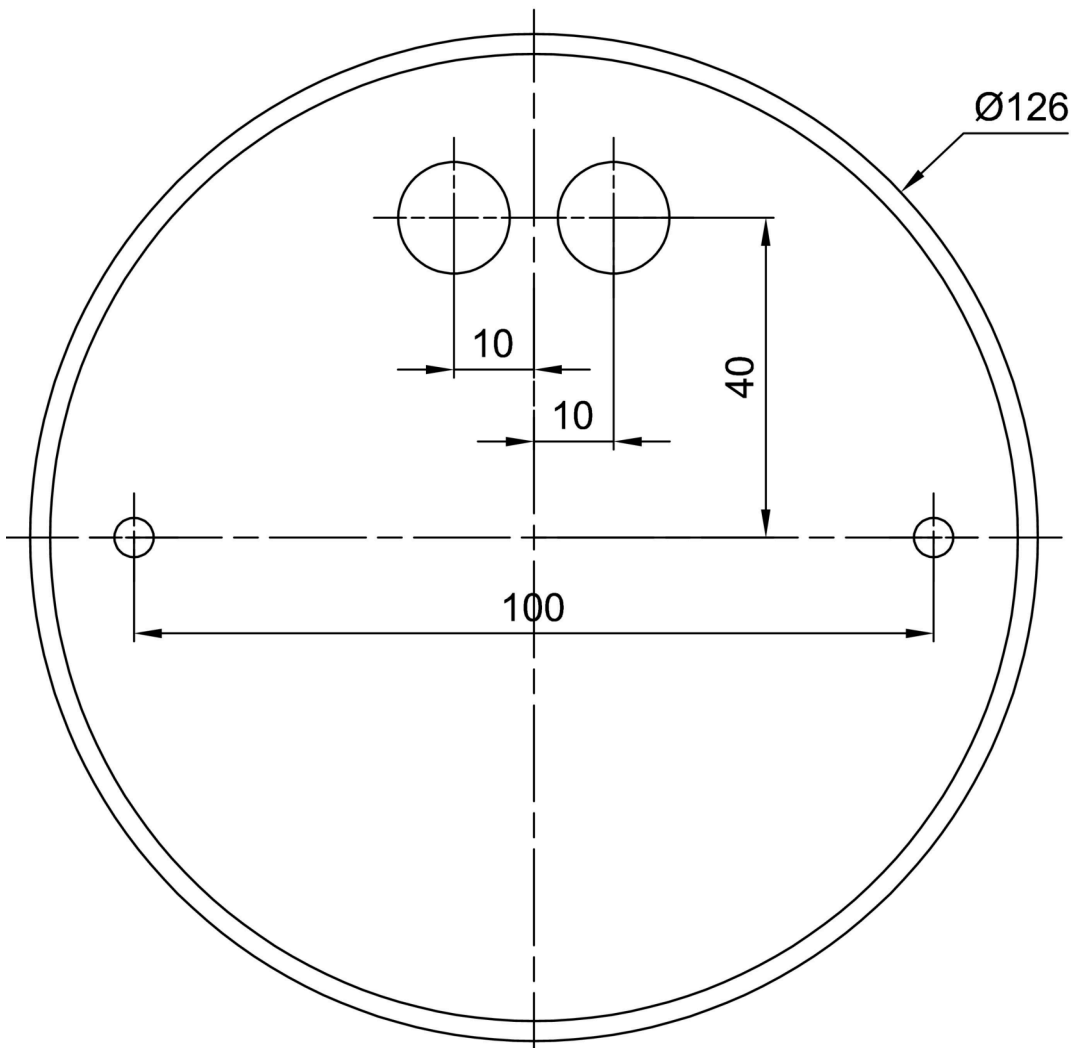

Additional assortment:

Lampshade

Product code	Name	Color	Description	Picture	Drawing
20070	028	white		