

## EDNA P4

---

IN-22ZK74/026/z4\*

[WWW.OSMONT.CZ](http://WWW.OSMONT.CZ)

# EDNA P4

Product code: EDN54104

Type: IN-22ZK74/026/z4\*

Short description of the luminaire: White pendant E27 light ON/OFF with TRIPLEX OPAL glass shade.



## Technical

Types of luminaires	Classic on/off
Mounting type	Suspended - rod
Base material	steel
Shade material	three-layer glass TRIPLEX OPAL
Base color	white Ral9003
Shade color	white
Holding the shade	folding system
Mounting location	ceiling
Width	420 mm
Length	420 mm
Height	125 mm
Diameter	ø 420 mm
Hinge length	800 mm
mounting holes (diameter)	2xø5mm
Installation wire (diameter)	2xø16mm
Impact strength	IK01
Operating temperature	from -20°C to +30°C

## Electric

Voltage type	AC
AC voltage	220 - 240 V
Power consumption	2x25 W
Ingress Protection	IP40
Socket	E27
terminal block	screw terminal block

## Luminous

Blue light hazard	Risk group 0
-------------------	--------------

Eulum data for calculation programs are available at [www.osmont.cz](http://www.osmont.cz).

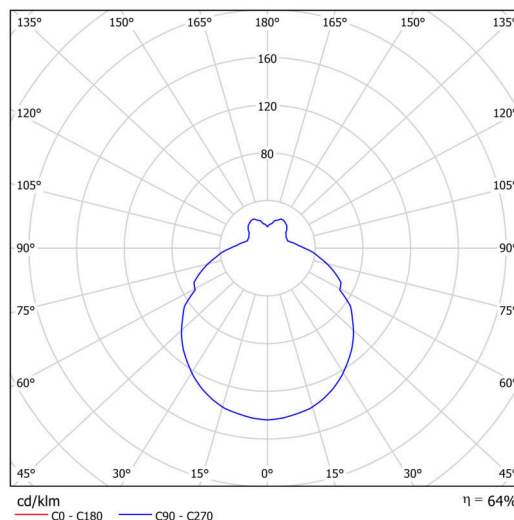
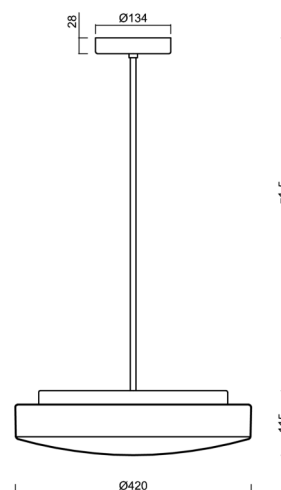

Logistic

EAN	8591728541040
Weight NTTO	5.1 Kg
Weight BTTO	6.9 Kg
Number of cartons	2 pcs
Package volume	0.052 m <sup>3</sup>
Package 1 width	0.435 m
Package 1 length	0.435 m
Package 1 height	0.13 m
Warranty*	60 months

\*The warranty for the batteries is valid for 12 months from the date of purchase.

Installation dimensions:

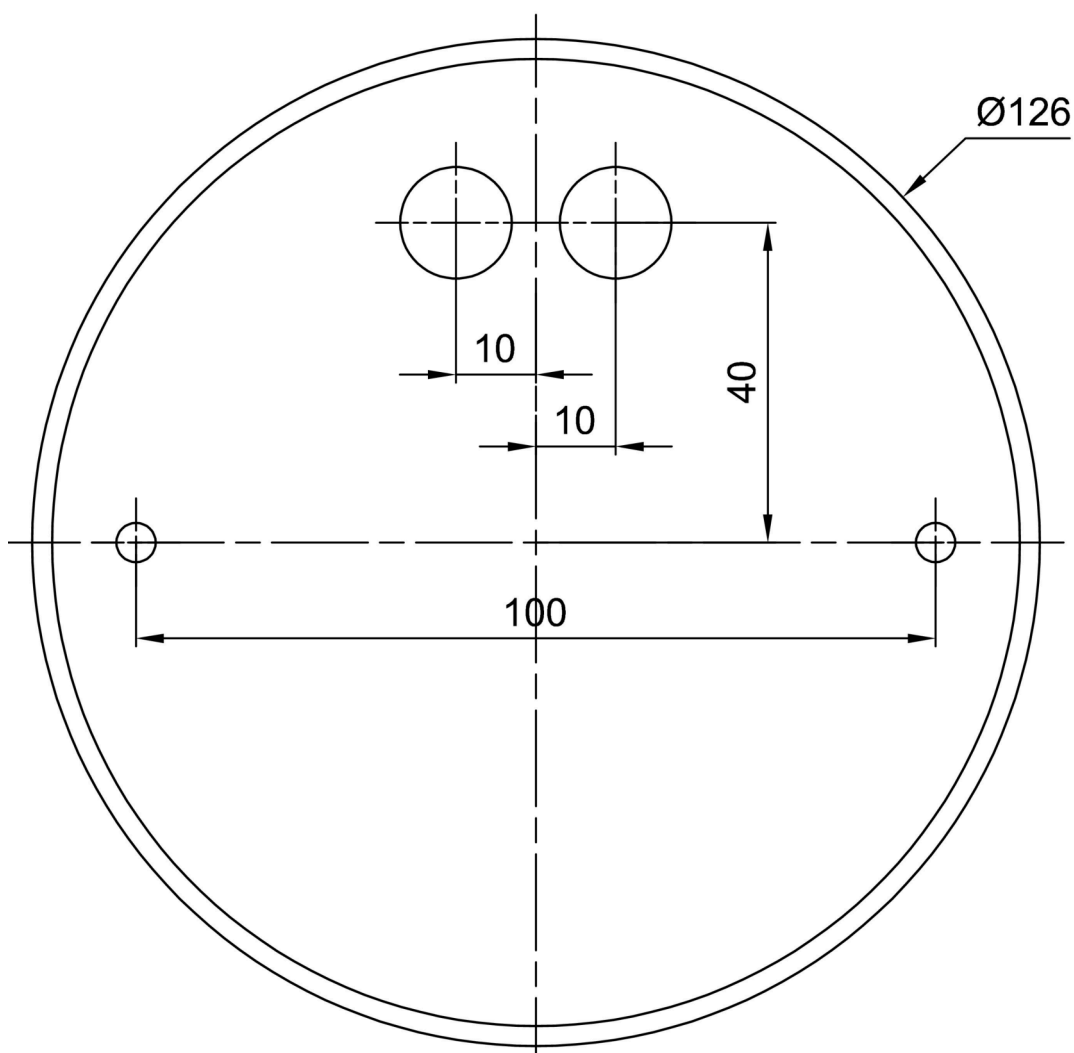

## Additional assortment:

## Lampshade

Product code	Name	Color	Description	Picture	Drawing
20054	026	white		