



## EDNA P3

---

LED-1L14EMP700ZK63/024/z1 4K#

[WWW.OSMONT.CZ](http://WWW.OSMONT.CZ)

# EDNA P3

Product code: EDN61565

Type: LED-1L14EMP700ZK63/024/z1 4K#

Short description of the luminaire: White pendant LED light ON/OFF with TRIPLEX OPAL glass shade.



## Technical

Types of luminaires	Classic on/off
Mounting type	Suspended - rod
Base material	steel
Shade material	three-layer glass TRIPLEX OPAL
Base color	white Ral9003
Shade color	white
Holding the shade	folding system
Mounting location	ceiling
Width	350 mm
Length	350 mm
Height	120 mm
Diameter	ø 350 mm
Hinge length	200 mm
mounting holes (diameter)	2xø5mm
Installation wire (diameter)	2xø16mm
Energy Class	D
Impact strength	IK01
Operating temperature	from -20°C to +30°C

## Electric

Power consumption	18 W
Ingress Protection	IP40
Socket	LED modul
terminal block	screw terminal block
Automatic circuit breaker type B10A	37 pcs
Automatic circuit breaker type B16A	59 pcs
Automatic circuit breaker type C10A	37 pcs
Automatic circuit breaker type C16A	59 pcs

## Luminous

Lum. flux of luminaire	1910 lm
Lum. flux of light source	2810 lm
Luminaire efficacy	106 lm/W
Temperature	4000 K
Rated life time LED L80/B10	100000 hours
CRI	Ra80
MacAdam	3
Blue light hazard	Risk group 0

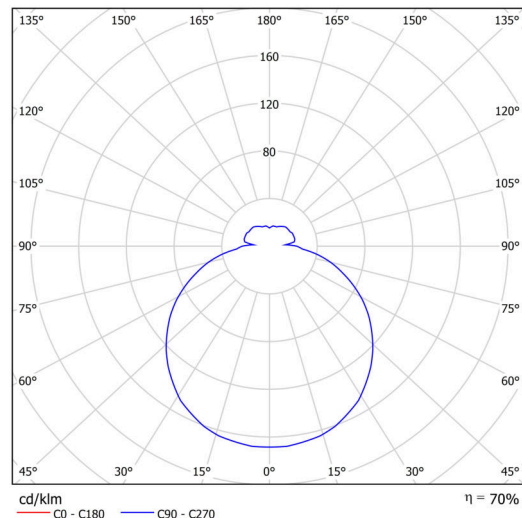
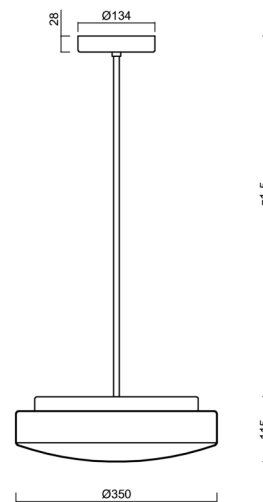
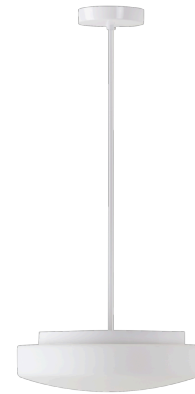

Eulum data for calculation programs are available at [www.osmont.cz](http://www.osmont.cz).

# TECHNICAL SHEET



## Multipower

Possibility of output adjustment by the user (DIP switch on the current source).

I [mA]	700	600	500	400	
[%]	100	86	71	57	

## Logistic

EAN	8591728093662
Weight NTTO	2.5 Kg
Weight BTTO	2.8 Kg
Number of cartons	2 pcs
Package volume	0.028 m <sup>3</sup>
Package 1 width	0.375 m
Package 1 length	0.355 m
Package 1 height	0.13 m
Warranty*	60 months

\*The warranty for the batteries is valid for 12 months from the date of purchase.

## Installation dimensions:

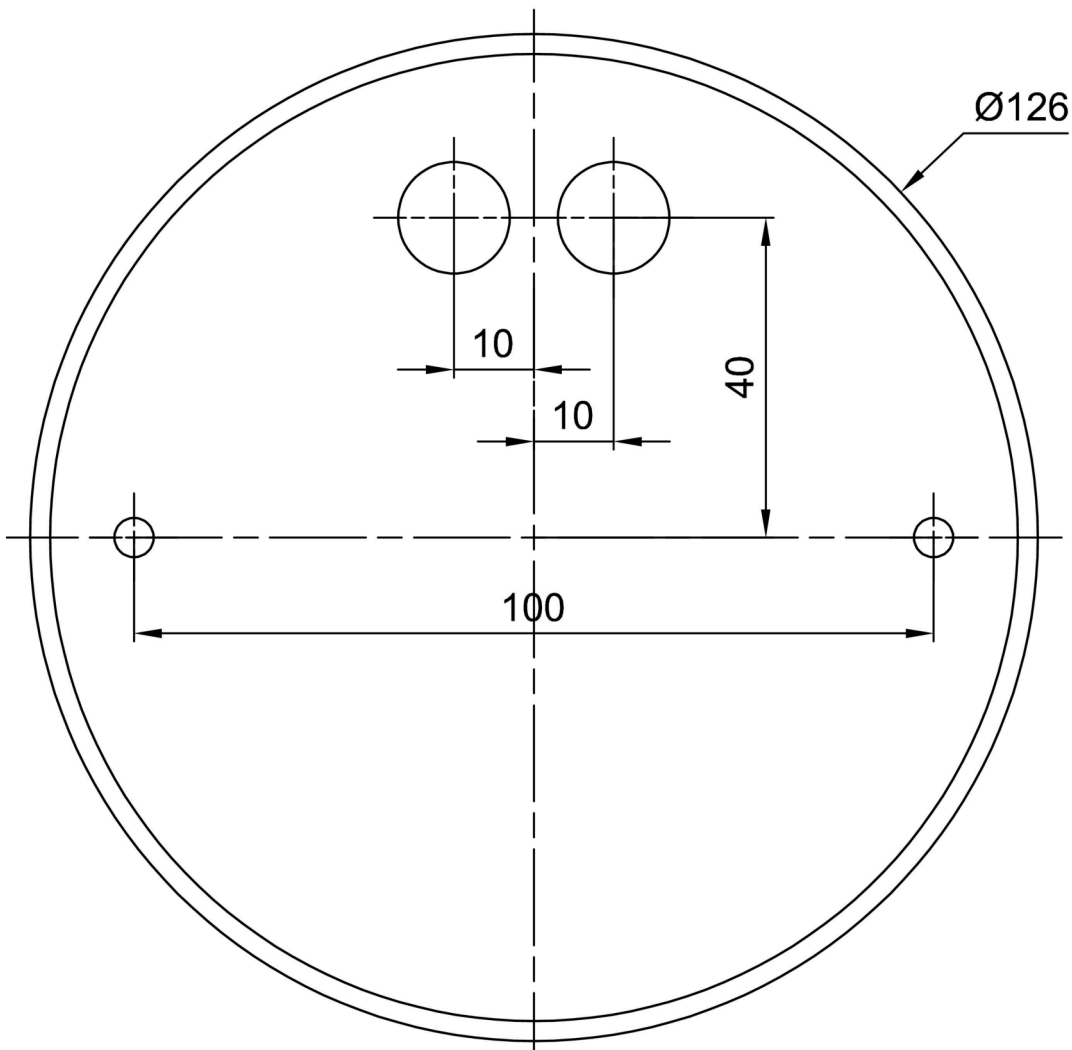

## Additional assortment:

## Lampshade

Product code	Name	Color	Description	Picture	Drawing
20011	024	white		