



## DELIA LC5

---

LED-9L52EMP1050ZLN11/PM26C/L100 4K##

[WWW.OSMONT.CZ](http://WWW.OSMONT.CZ)

# DELIA LC5

Product code: DEL69929

Type: LED-9L52EMP1050ZLN11/PM26C/L100 4K##

Short description of the luminaire: White pendant LED light ON/OFF and PMMA shade.



## Technical

Types of luminaires	Classic on/off
Mounting type	Suspended - wire
Base material	steel
Shade material	opal polymethyl methacrylate
Base color	white Ra9003
Shade color	white - black
Holding the shade	folding system
Mounting location	ceiling
Width	900 mm
Length	900 mm
Height	90 mm
Diameter	ø 900 mm
Hinge length	1000 mm
mounting holes (diameter)	2xø5mm
Installation wire (diameter)	2xø16mm
Energy Class	D
Impact strength	IK04
Operating temperature	from -20°C to +30°C

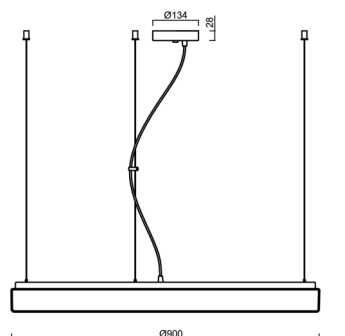

## Electric

Power consumption	150 W
Ingress Protection	IP40
Socket	LED modul
terminal block	screw terminal block
Automatic circuit breaker type B10A	8 pcs
Automatic circuit breaker type B16A	13 pcs
Automatic circuit breaker type C10A	8 pcs
Automatic circuit breaker type C16A	13 pcs

## Luminous

Lum. flux of luminaire	16600 lm
Lum. flux of light source	23720 lm
Luminaire efficacy	110 lm/W
Temperature	4000 K
Rated life time LED L80/B10	100000 hours
CRI	Ra80
MacAdam	3
Blue light hazard	Risk group 0



Eulum data for calculation programs are available at [www.osmont.cz](http://www.osmont.cz).

# TECHNICAL SHEET



## Multipower

Possibility of output adjustment by the user (DIP switch on the current source).

I [mA]	1050	900	850	700	
[%]	100	86	81	67	

## Logistic

EAN	8591728079635
Weight NTTO	10.5 Kg
Weight BTTO	13.2 Kg
Number of cartons	1 pcs
Package volume	0.205 m <sup>3</sup>
Package 1 width	0.94 m
Package 1 length	0.95 m
Package 1 height	0.23 m
Warranty*	60 months

\*The warranty for the batteries is valid for 12 months from the date of purchase.

## Installation dimensions:

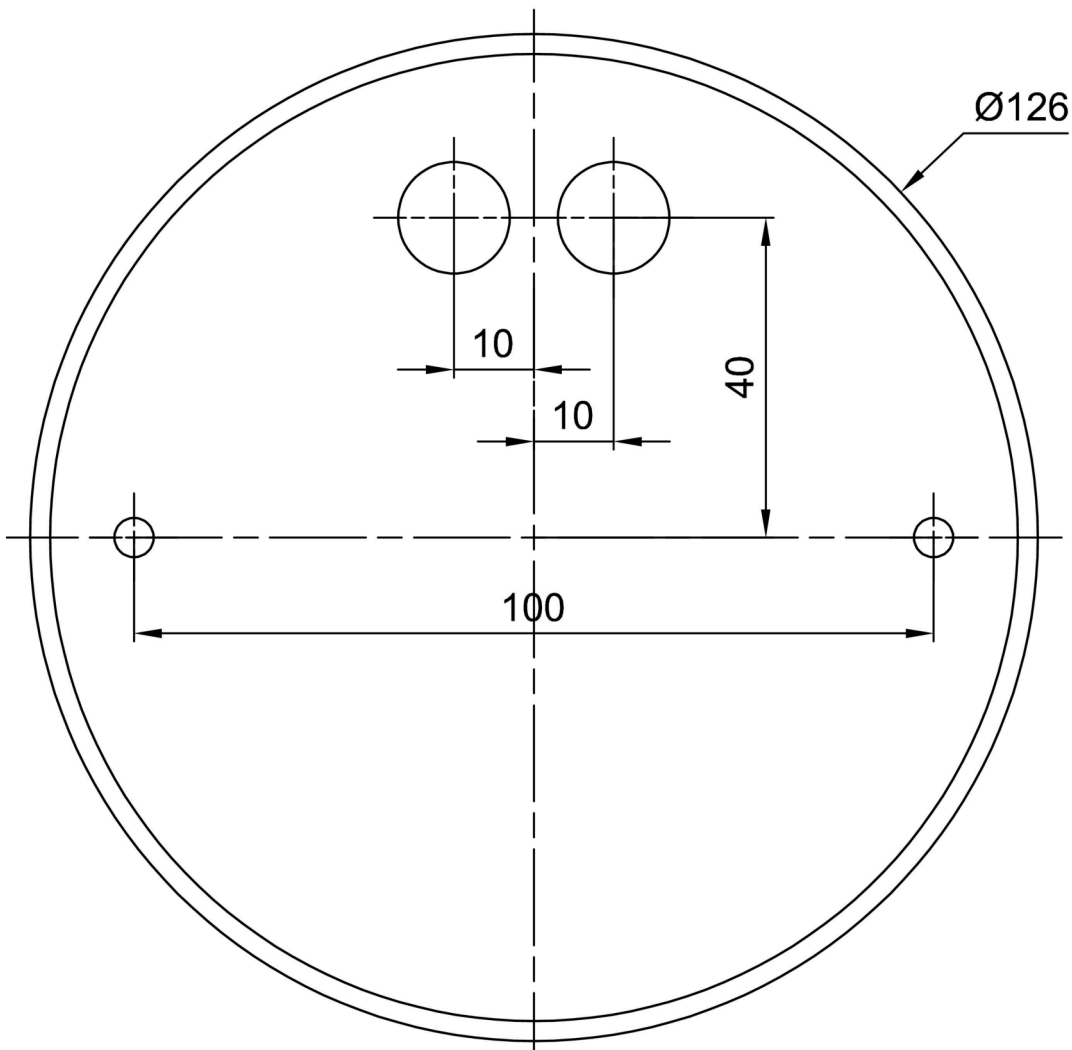

## Additional assortment:

## Lampshade

Product code	Name	Color	Description	Picture	Drawing
20574	PM26C	white - black		