



DELIA LC5

LED-9L52EMP700ZLN11/PM26C/L100 3K##

WWW.OSMONT.CZ

DELIA LC5

Product code: DEL69426

Type: LED-9L52EMP700ZLN11/PM26C/L100 3K##

Short description of the luminaire: White pendant LED light ON/OFF and PMMA shade.



Technical

Types of luminaires	Classic on/off
Mounting type	Suspended - wire
Base material	steel
Shade material	opal polymethyl methacrylate
Base color	white Ra9003
Shade color	white - black
Holding the shade	folding system
Mounting location	ceiling
Width	900 mm
Length	900 mm
Height	90 mm
Diameter	ø 900 mm
Hinge length	1000 mm
mounting holes (diameter)	2xø5mm
Installation wire (diameter)	2xø16mm
Energy Class	D
Impact strength	IK04
Operating temperature	from -20°C to +30°C

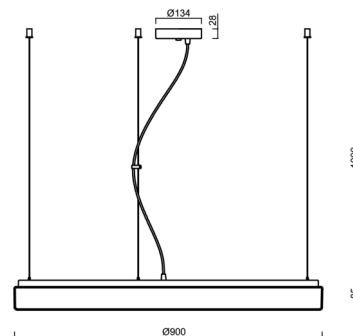

Electric

Power consumption	98 W
Ingress Protection	IP40
Socket	LED modul
terminal block	screw terminal block
Automatic circuit breaker type B10A	12 pcs
Automatic circuit breaker type B16A	19 pcs
Automatic circuit breaker type C10A	12 pcs
Automatic circuit breaker type C16A	19 pcs

Luminous

Lum. flux of luminaire	11050 lm
Lum. flux of light source	15780 lm
Luminaire efficacy	112 lm/W
Temperature	3000 K
Rated life time LED L80/B10	100000 hours
CRI	Ra80
MacAdam	3
Blue light hazard	Risk group 0



Eulum data for calculation programs are available at www.osmont.cz.

TECHNICAL SHEET



Multipower

Possibility of output adjustment by the user (DIP switch on the current source).

I [mA]	700	600	500	400	
[%]	100	86	71	57	

Logistic

EAN	8591728078010
Weight NTTO	10 Kg
Weight BTTO	12.7 Kg
Number of cartons	1 pcs
Package volume	0.205 m ³
Package 1 width	0.95 m
Package 1 length	0.23 m
Package 1 height	0.94 m
Warranty*	60 months

*The warranty for the batteries is valid for 12 months from the date of purchase.

Installation dimensions:

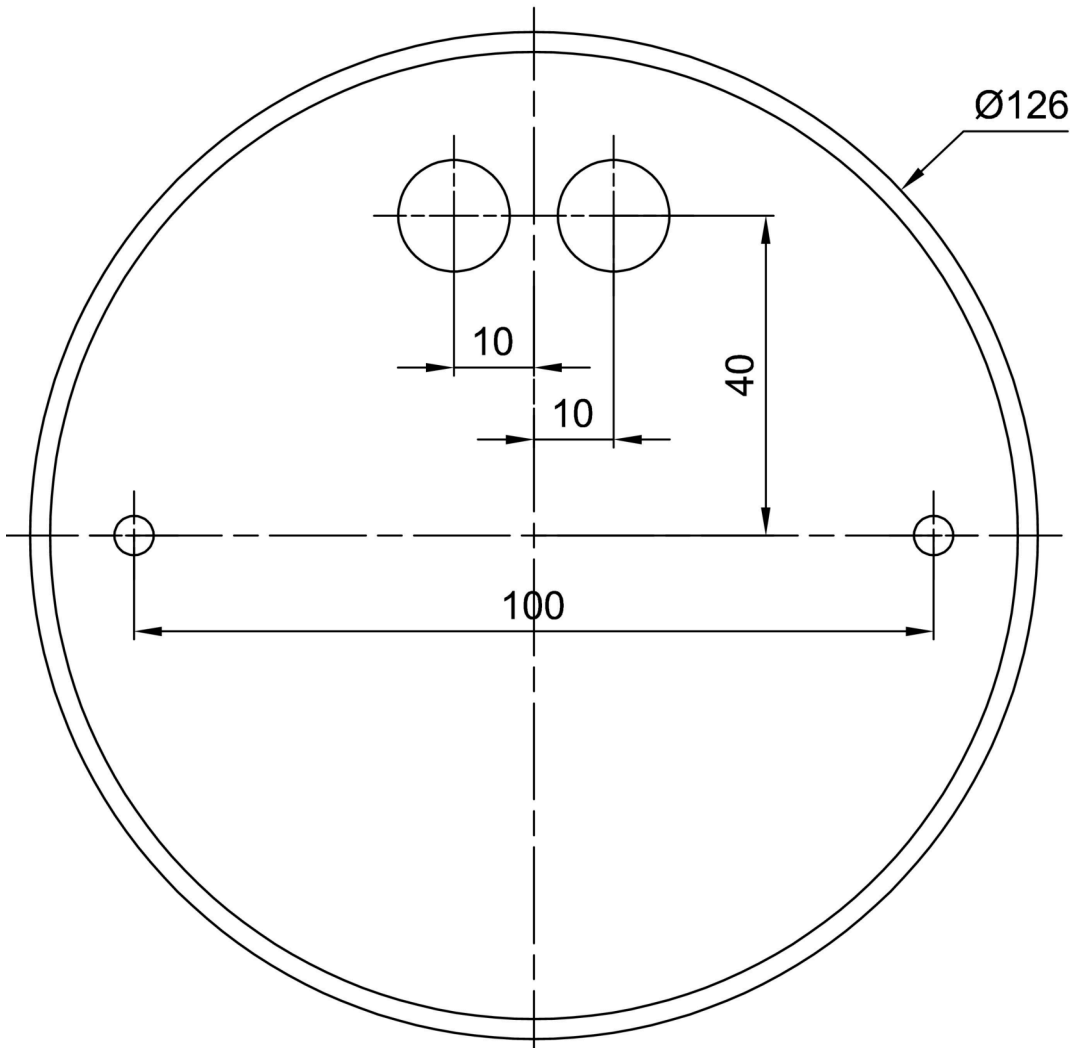

Additional assortment:

Lampshade

Product code	Name	Color	Description	Picture	Drawing
20574	PM26C	white - black		