



DELIA LC4

LED-6L51E700ZLN10/PM25C/L100 DALI 4K##

WWW.OSMONT.CZ

DELIA LC4

Product code: DEL69921

Type: LED-6L51E700ZLN10/PM25C/L100 DALI 4K##

Short description of the luminaire: White pendant LED light DALI and PMMA shade.



Technical

Types of luminaires	Dimmable
Mounting type	Suspended - wire
Base material	steel
Shade material	opal polymethyl methacrylate
Base color	white Ra9003
Shade color	white - black
Holding the shade	folding system
Mounting location	ceiling
Width	650 mm
Length	650 mm
Height	85 mm
Diameter	ø 650 mm
Hinge length	1000 mm
mounting holes (diameter)	2xø5mm
Installation wire (diameter)	2xø16mm
Energy Class	D
Impact strength	IK04
Operating temperature	from -20°C to +30°C

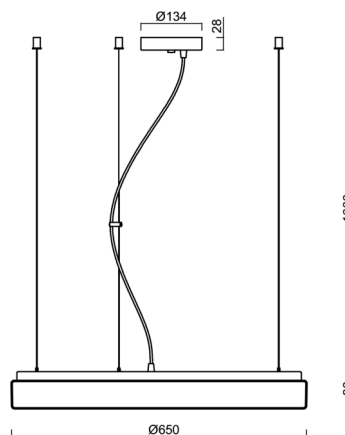
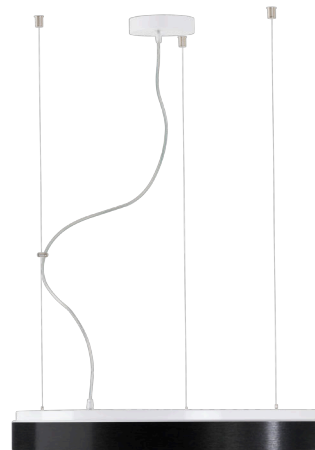

Electric

Power consumption	65 W
Ingress Protection	IP40
Socket	LED modul
terminal block	screw terminal block
Automatic circuit breaker type B10A	9 pcs
Automatic circuit breaker type B16A	14 pcs
Automatic circuit breaker type C10A	15 pcs
Automatic circuit breaker type C16A	23 pcs

Luminous

Lum. flux of luminaire	7250 lm
Lum. flux of light source	10980 lm
Luminaire efficacy	111 lm/W
Temperature	4000 K
Rated life time LED L80/B10	100000 hours
CRI	Ra80
MacAdam	3
Blue light hazard	Risk group 0

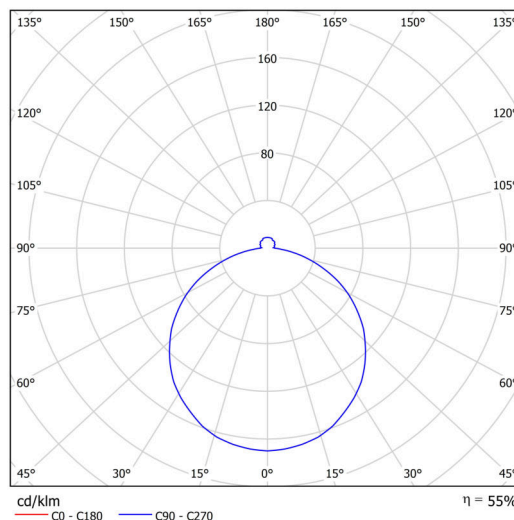

Eulum data for calculation programs are available at www.osmont.cz.

Logistic

EAN	8591728079581
Weight NTTO	5.6 Kg
Weight BTTO	7 Kg
Number of cartons	1 pcs
Package volume	0.08 m ³
Package 1 width	0.68 m
Package 1 length	0.17 m
Package 1 height	0.69 m
Warranty*	60 months

*The warranty for the batteries is valid for 12 months from the date of purchase.

Installation dimensions:



Additional assortment:

Lampshade

Product code	Name	Color	Description	Picture	Drawing
20573	PM25C	white - black		