



DELIA L5

LED-9L52E700ZLN11/PC26/L100 DALI 4K##

WWW.OSMONT.CZ

DELIA L5

Product code: DEL58844

Type: LED-9L52E700ZLN11/PC26/L100 DALI 4K##

Short description of the luminaire: White colour | pendant LED light DALI | opal polycarbonate shade (PC)| steel wire pendant (with supply cable) 100 cm |



Technical data

Types of luminaires	Dimmable
Mounting type	Suspended - wire
Base material	steel
Shade material	opal polycarbonate
Base color	white Ral9003
Shade color	white
Holding the shade	folding system
Mounting location	ceiling
Width	900 mm
Length	900 mm
Height	85 mm
Diameter	ø 900 mm
Suspension length	1000 mm
mounting holes (diameter)	2xø5mm
Cable entrance	2xø16mm
Energy Class	D
Impact strength	IK10
Operating temperature	from -20°C to +30°C

Electrical data

Power consumption	98 W
Ingress Protection	IP40
Socket	LED modul
terminal block	screw terminal block
Automatic circuit breaker type B10A	7 pcs
Automatic circuit breaker type B16A	12 pcs
Automatic circuit breaker type C10A	12 pcs
Automatic circuit breaker type C16A	20 pcs
Number of LED drivers	3

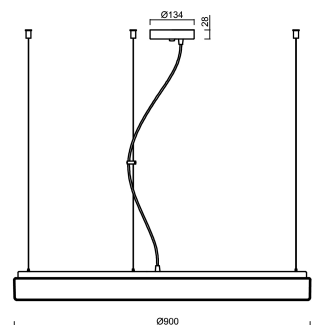

Luminous data

Lum. flux of luminaire	11520 lm
Lum. flux of light source	16460 lm
Luminaire efficacy	117 lm/W
Chromaticity temperature	4000 K
Rated life time LED L80/B10	100000 hours
CRI	Ra80
MacAdam	3
Blue light hazard	Risk group 0

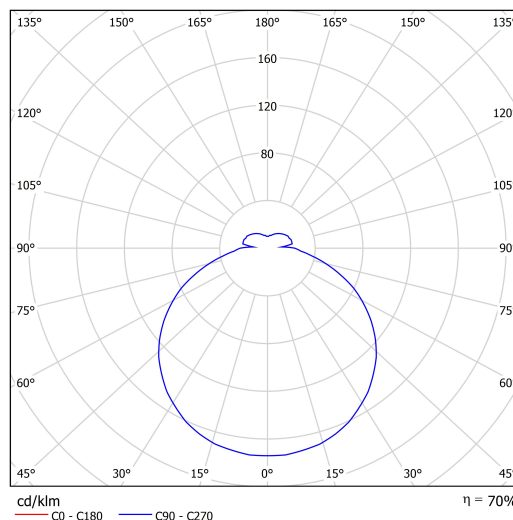

Eulum data for calculation programs are available at

OSMONT, s.r.o.
HYBRÁLEC 129,
586 01 JIHLAVA, CZ

Logistical data

EAN	8591728193379
Weight NTTO	10 Kg
Weight BTTO	12.7 Kg
Warranty*	60 months

*The warranty for the batteries is valid for 36 months from the date of purchase.

Installation dimensions:

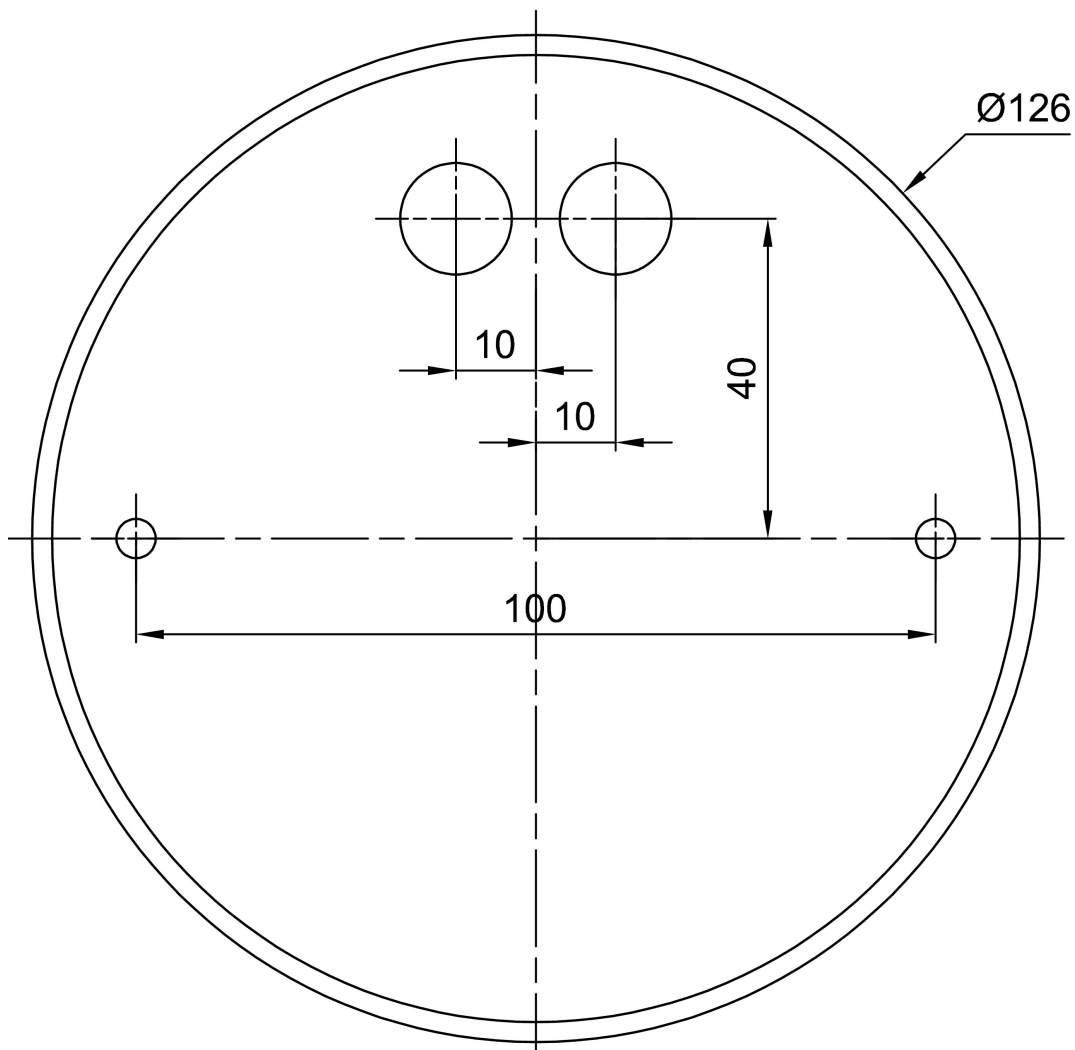

Additional assortment:

Lampshade

Product code	Name	Color	Picture	Drawing
20655	PC26	white	