

DELIA L4

LED-6L51E1050ZLN10/PC25/L100 DALI 3K##

WWW.OSMONT.CZ

DELIA L4

Product code: DEL58833

Type: LED-6L51E1050ZLN10/PC25/L100 DALI 3K##

Short description of the luminaire: White colour | pendant LED light DALI | opal polycarbonate shade (PC)| steel wire pendant (with supply cable) 100 cm |

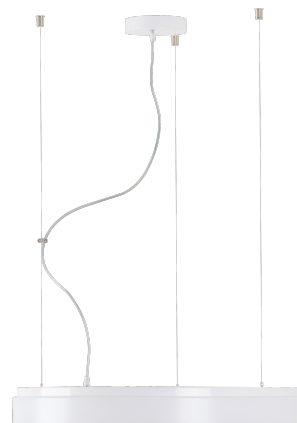

Technical data

Types of luminaires	Dimmable
Mounting type	Suspended - wire
Base material	steel
Shade material	opal polycarbonate
Base color	white Ral9003
Shade color	white
Holding the shade	folding system
Mounting location	ceiling
Width	650 mm
Length	650 mm
Height	80 mm
Diameter	ø 650 mm
Suspension length	1000 mm
mounting holes (diameter)	2xø5mm
Cable entrance	2xø16mm
Energy Class	D
Impact strength	IK10
Operating temperature	from -20°C to +30°C

Electrical data

Power consumption	100 W
Ingress Protection	IP40
Socket	LED modul
terminal block	screw terminal block
Automatic circuit breaker type B10A	7 pcs
Automatic circuit breaker type B16A	11 pcs
Automatic circuit breaker type C10A	11 pcs
Automatic circuit breaker type C16A	18 pcs
Number of LED drivers	2

Luminous data

Lum. flux of luminaire	10010 lm
Lum. flux of light source	15160 lm
Luminaire efficacy	100 lm/W
Chromaticity temperature	3000 K
Rated life time LED L80/B10	100000 hours
CRI	Ra80
MacAdam	3
Blue light hazard	Risk group 0

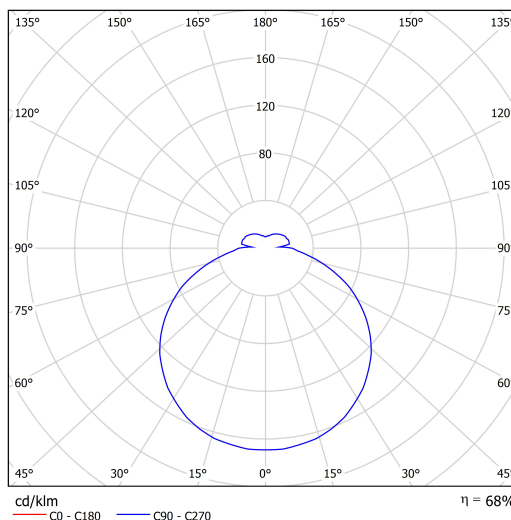
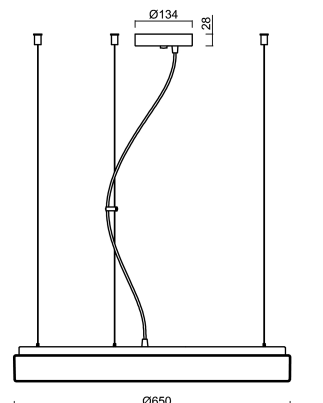

Eulum data for calculation programs are available at

OSMONT, s.r.o.
 HYBRÁLEC 129,
 586 01 JIHLAVA, CZ

Logistical data

EAN	8591728193263
Weight NTTO	6.1 Kg
Weight BTTO	7.5 Kg
Warranty*	60 months

*The warranty for the batteries is valid for 36 months from the date of purchase.

Installation dimensions:

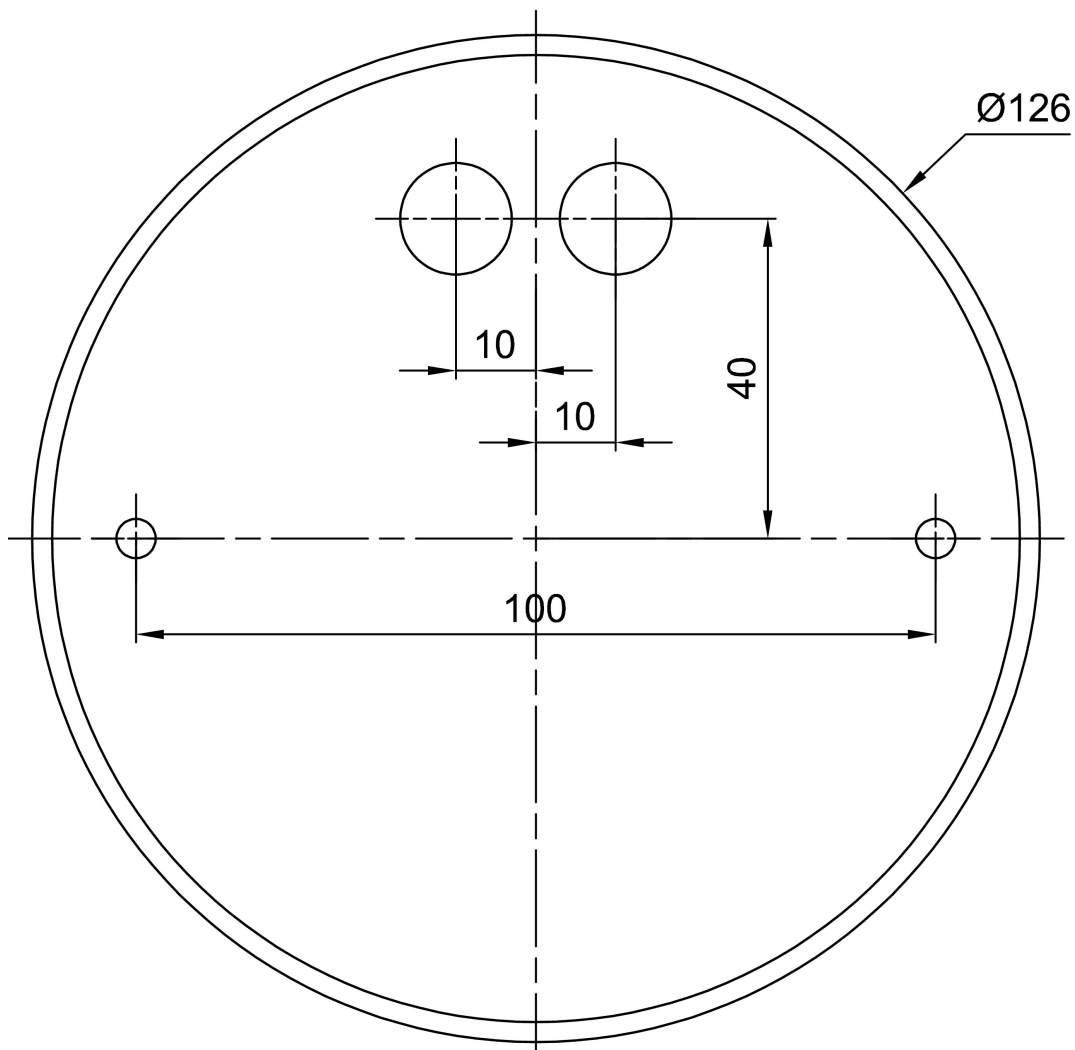

Additional assortment:

Lampshade

Product code	Name	Color	Picture	Drawing
20654	PC25	white	