



DELIA C2A

IN-22KN73/PC19C HF*

WWW.OSMONT.CZ

DELIA C2A

Product code: DEL52591

Type: IN-22KN73/PC19C HF*

Short description of the luminaire: White surface-mounted E27 light with sensor and polycarbonate shade.

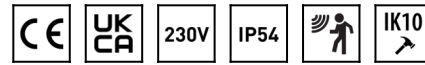

Technical

Types of luminaires	Sensor
Mounting type	surface mounted
Base material	steel
Shade material	opal polycarbonate
Base color	white Ral9003
Shade color	white - black
Holding the shade	folding system
Mounting location	ceiling/wall
Width	360 mm
Length	360 mm
Height	71 mm
Diameter	ø 360 mm
mounting holes (diameter)	3xø5mm
Installation wire (diameter)	2xø16mm
Impact strength	IK10
Operating temperature	from -20°C to +30°C

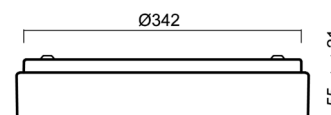
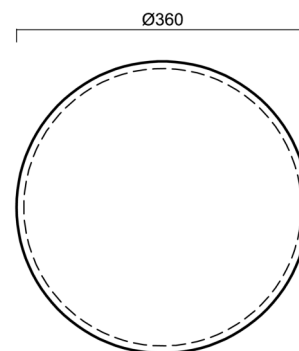

Electric

Voltage type	AC
AC voltage	220 - 240 V
Power consumption	2x25 W
Ingress Protection	IP54
Socket	E27
Sensor	HF
terminal block	snap terminal block

Luminous

Blue light hazard	Risk group 0
-------------------	--------------

Eulum data for calculation programs are available at www.osmont.cz.

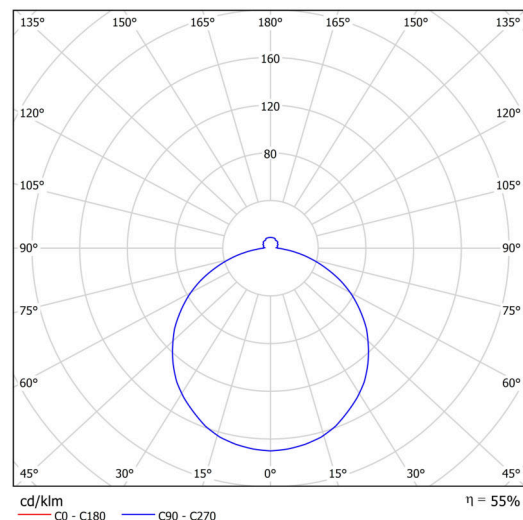

Logistic

EAN	8591728525910
Weight NTTO	1.15 Kg
Weight BTTO	1.35 Kg
Number of cartons	1 pcs
Package volume	0.019 m ³
Package 1 width	0.385 m
Package 1 length	0.37 m
Package 1 height	0.13 m
Warranty*	60 months

*The warranty for the batteries is valid for 12 months from the date of purchase.

Installation dimensions:

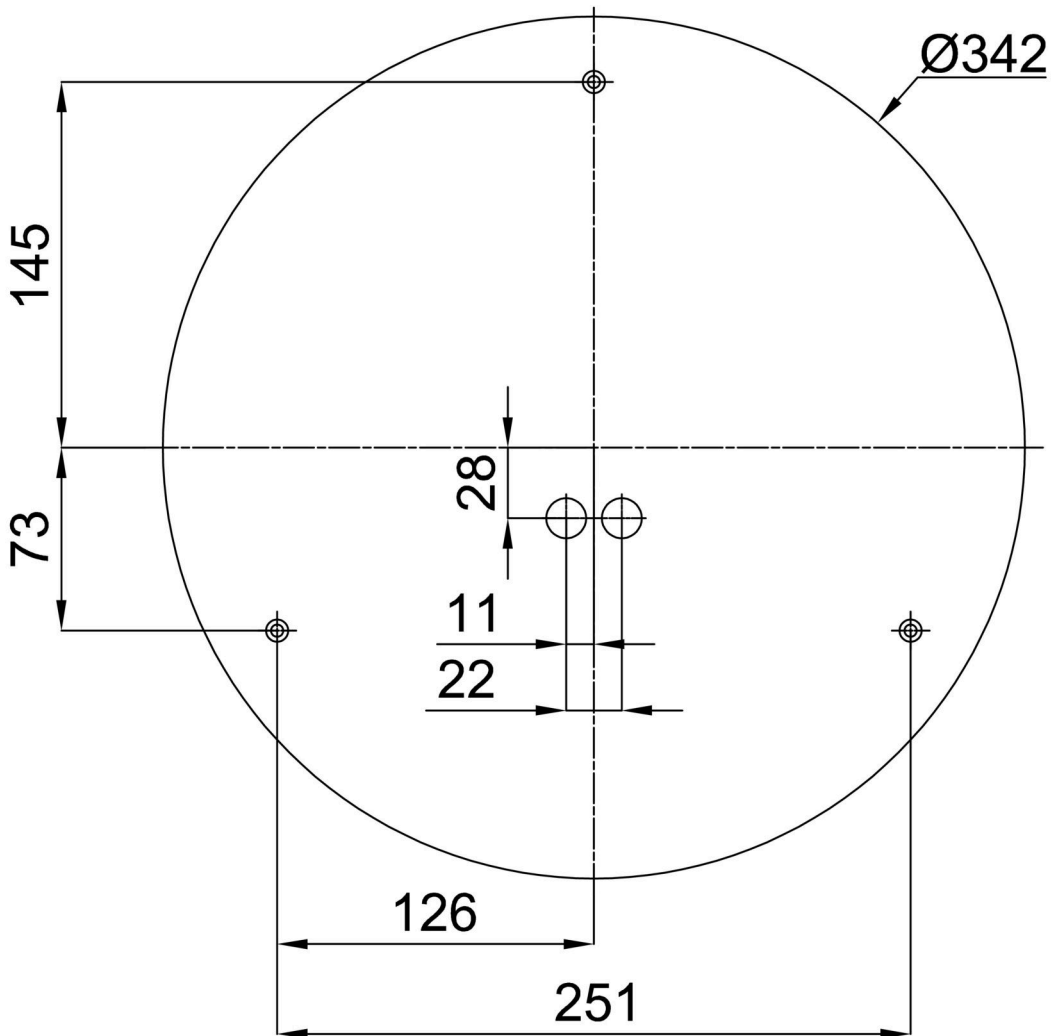

Additional assortment:

Base for surface mounting

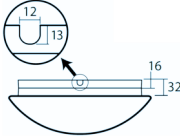
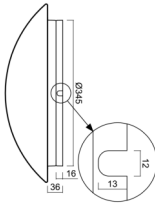
Product code	Name	Color	Description	Picture	Drawing
33506	B15/BP	white Ral9003			

Lampshade

Product code	Name	Color	Description	Picture	Drawing
20567	PC19C	white - black		