



## DELIA C2

---

LED-1L16E500KN83/PM23C/NK1W 4K#

[WWW.OSMONT.CZ](http://WWW.OSMONT.CZ)

# DELIA C2

Product code: DEL69568

Type: LED-1L16E500KN83/PM23C/NK1W 4K#

Short description of the luminaire: White colour | ceiling or wall LED light with emergency backup combined | PMMA shade with black decorative stripe|



## Technical

Types of luminaires	Emergency combined
Mounting type	surface mounted
Base material	steel
Shade material	opal polymethyl methacrylate
Base color	white Ral9003
Shade color	white - black
Holding the shade	folding system
Mounting location	ceiling/wall
Width	400 mm
Length	400 mm
Height	80 mm
Diameter	ø 400 mm
mounting holes (diameter)	3xø5mm
Cable entrance	2xø16mm
Energy Class	D
Impact strength	IK04
Operating temperature	from 0°C to +30°C

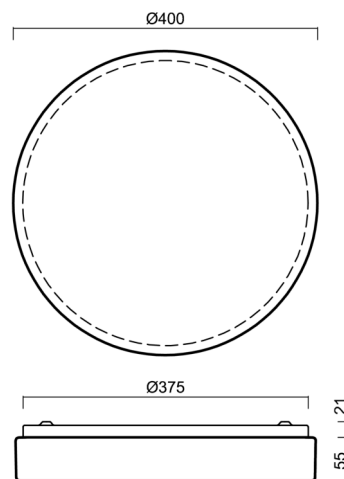

## Electric

Power consumption	24 W
Ingress Protection	IP54
Socket	LED modul
Battery type	NiCd
Emergency time	3 hours
SELFTEST	no
terminal block	snap terminal block
Automatic circuit breaker type B10A	26 pcs
Automatic circuit breaker type B16A	40 pcs
Automatic circuit breaker type C10A	30 pcs
Automatic circuit breaker type C16A	48 pcs

## Luminous

Lum. flux of luminaire	2150 lm
Lum. flux of light source	3910 lm
Lum. flux of light source in emergency mode	150 lm
Luminaire efficacy	89 lm/W
Temperature	4000 K
Rated life time LED L80/B10	100000 hours
CRI	Ra80
MacAdam	3

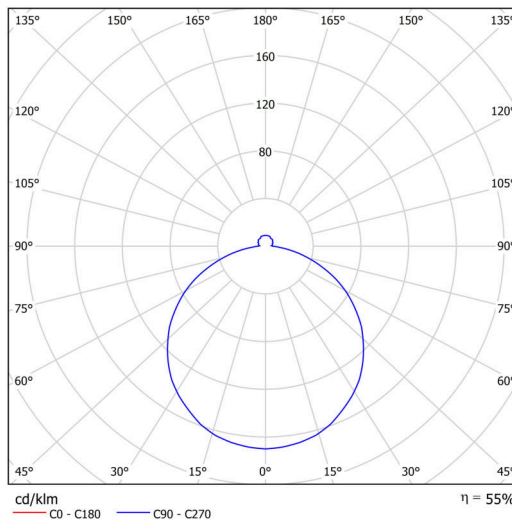

# TECHNICAL SHEET



Blue light hazard	Risk group 0
-------------------	--------------

Eulum data for calculation programs are available at [www.osmont.cz](http://www.osmont.cz).

## Logistic

EAN	8591728078591
Weight NTTO	1.8 Kg
Weight BTTO	2.2 Kg
Number of cartons	1 pcs
Package volume	0.015 m <sup>3</sup>
Package 1 width	0.41 m
Package 1 length	0.41 m
Package 1 height	0.09 m
Warranty*	60 months

\*The warranty for the batteries is valid for 12 months from the date of purchase.

## Installation dimensions:

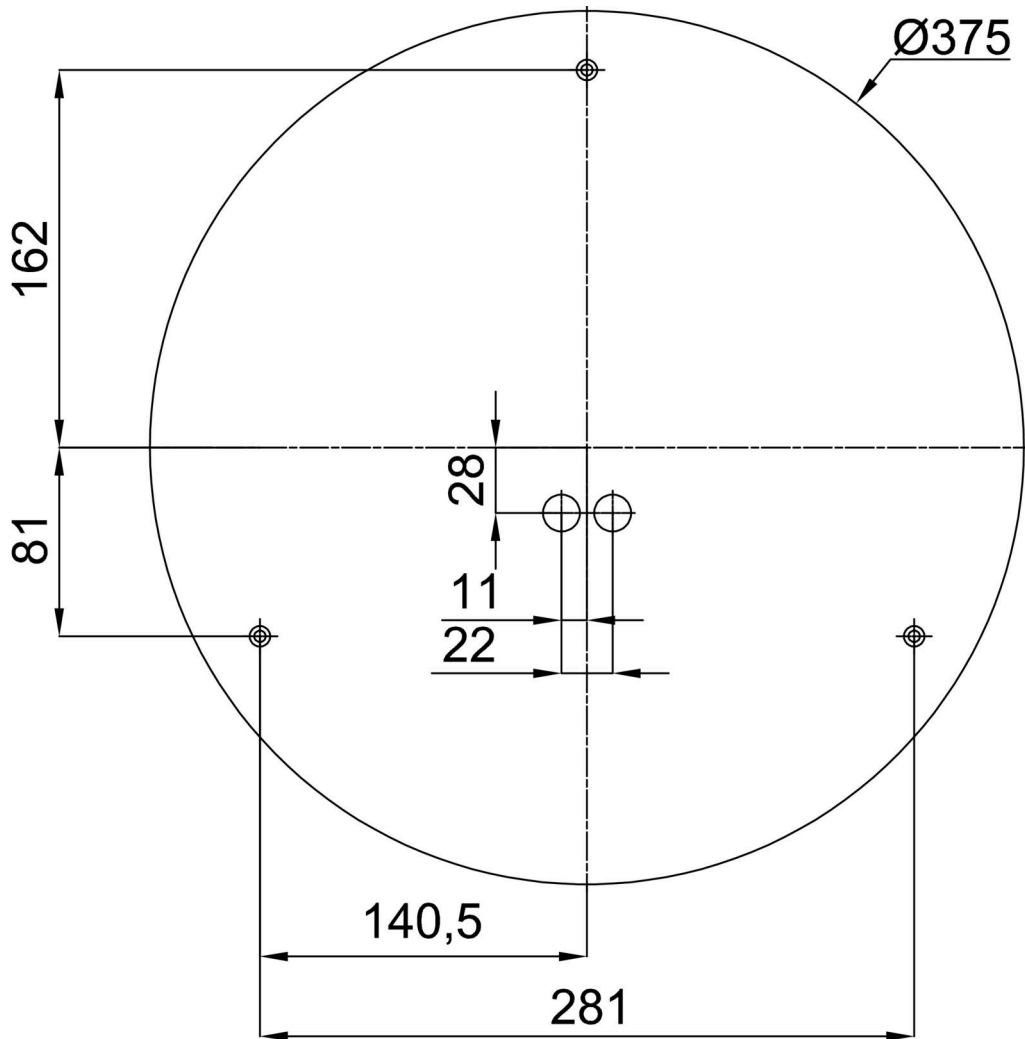

Additional assortment:

Base for surface mounting

Product code	Name	Color	Description	Picture	Drawing
33502	KN8,K8/BP	white Ra19003	příslušenství		

Lampshade

Product code	Name	Color	Description	Picture	Drawing
20571	PM23C	white - black	příslušenství	