



DELIA C2

LED-1L16E700KN83/PC23C DALI 3K#

WWW.OSMONT.CZ

DELIA C2

Product code: DEL69038

Type: LED-1L16E700KN83/PC23C DALI 3K#

Short description of the luminaire: White colour | ceiling or wall LED light DALI | opal polycarbonate shade (PC) with black decorative stripe|

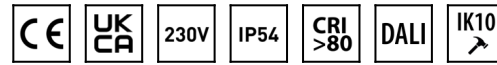

Technical

Types of luminaires	Dimmable
Mounting type	surface mounted
Base material	steel
Shade material	opal polycarbonate
Base color	white Ral9003
Shade color	white - black
Holding the shade	folding system
Mounting location	ceiling/wall
Width	400 mm
Length	400 mm
Height	80 mm
Diameter	ø 400 mm
mounting holes (diameter)	3xø5mm
Cable entrance	2xø16mm
Energy Class	D
Impact strength	IK10
Operating temperature	from -20°C to +30°C

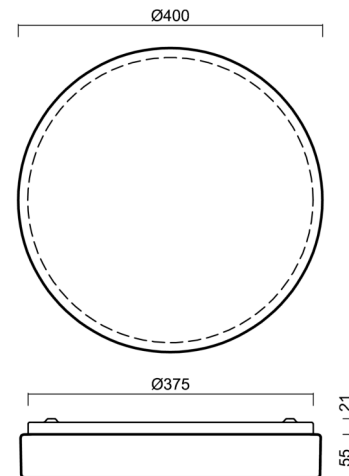

Electric

Power consumption	34 W
Ingress Protection	IP54
Socket	LED modul
terminal block	snap terminal block
Automatic circuit breaker type B10A	18 pcs
Automatic circuit breaker type B16A	28 pcs
Automatic circuit breaker type C10A	30 pcs
Automatic circuit breaker type C16A	46 pcs

Luminous

Lum. flux of luminaire	2780 lm
Lum. flux of light source	5050 lm
Luminaire efficacy	81 lm/W
Temperature	3000 K
Rated life time LED L80/B10	100000 hours
CRI	Ra80
MacAdam	3
Blue light hazard	Risk group 0

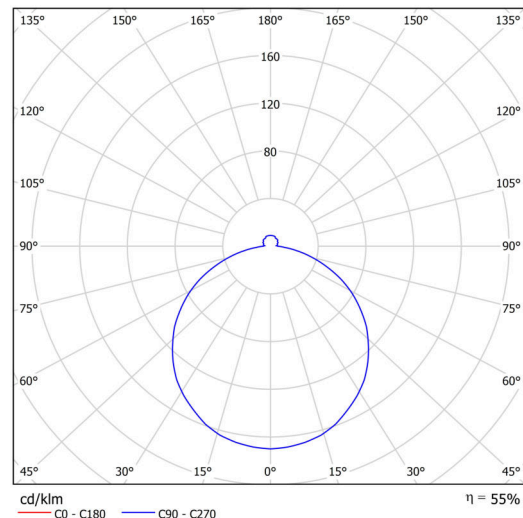

Eulum data for calculation programs are available at www.osmont.cz.

Logistic

EAN	8591728076702
Weight NTTO	1.8 Kg
Weight BTTO	2.2 Kg
Number of cartons	1 pcs
Package volume	0.015 m ³
Package 1 width	0.41 m
Package 1 length	0.41 m
Package 1 height	0.09 m
Warranty*	60 months

*The warranty for the batteries is valid for 12 months from the date of purchase.

Installation dimensions:

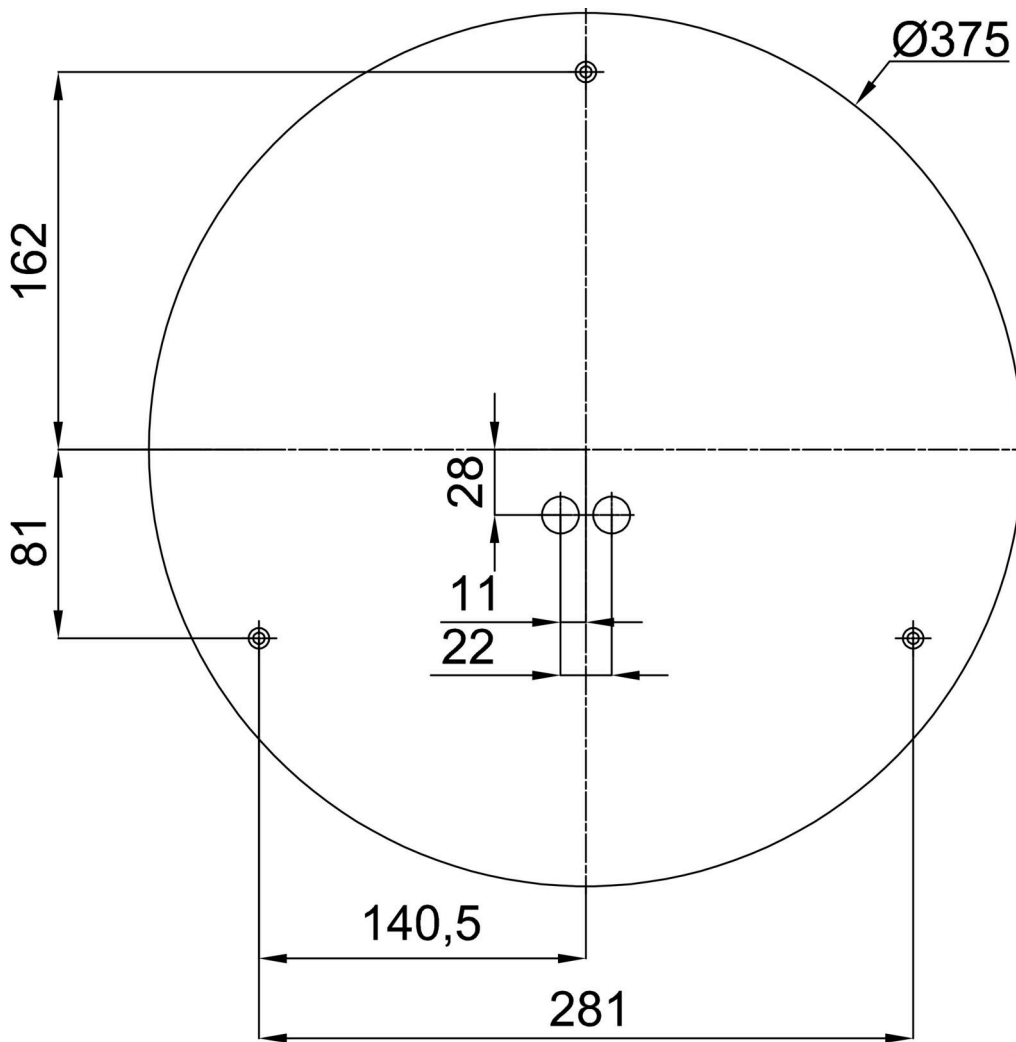

Additional assortment:

Base for surface mounting

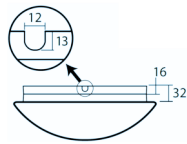
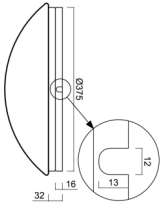
Product code	Name	Color	Description	Picture	Drawing
33502	KN8,K8/BP	white Ra19003	příslušenství		

Lampshade

Product code	Name	Color	Description	Picture	Drawing
20568	PC23C	white - black	příslušenství	