



DELIA 5

LED-9L52EMP700KN11/PC26 NK3H 3K##

WWW.OSMONT.CZ

DELIA 5

Product code: DEL58797

Type: LED-9L52EMP700KN11/PC26 NK3H 3K##

Short description of the luminaire: White colour | ceiling or wall LED light with emergency backup combined | multipower driver | opal polycarbonate shade (PC)



Technical data

Types of luminaires	Emergency combined
Mounting type	surface mounted
Base material	steel
Shade material	opal polycarbonate
Base color	white Ral9003
Shade color	white
Holding the shade	folding system
Mounting location	ceiling/wall
Width	900 mm
Length	900 mm
Height	86 mm
Diameter	ø 900 mm
mounting holes (diameter)	3xø5mm
Cable entrance	2xø16mm
Energy Class	D
Impact strength	IK10
Operating temperature	from -20°C to +30°C

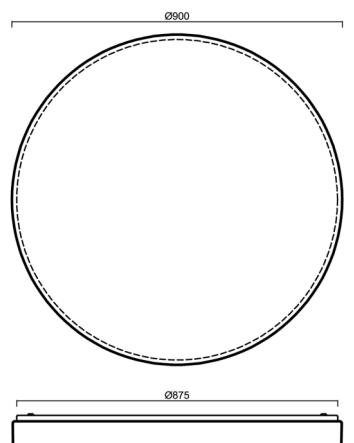

Electrical data

Power consumption	98 W
Ingress Protection	IP54
Socket	LED modul
Battery type	LiFePO4
Emergency time	3 hours
terminal block	snap terminal block

Luminous data

Lum. flux of luminaire	11050 lm
Lum. flux of light source	15780 lm
Lum. flux of light source in emergency mode	200 lm
Chromaticity temperature	3000 K
Rated life time LED L80/B10	100000 hours
CRI	Ra80
MacAdam	3
Blue light hazard	Risk group 0

Eulum data for calculation programs are available at www.osmont.cz.

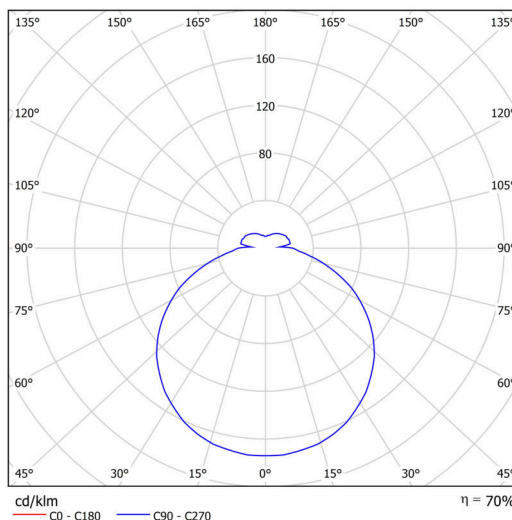

TECHNICAL SHEET



Logistical data

EAN	8591728192907
Weight NTTO	9.9 Kg
Weight BTTO	12.6 Kg
Number of cartons	1 pcs
Warranty*	60 months

*The warranty for the batteries is valid for 36 months from the date of purchase.

Installation dimensions:

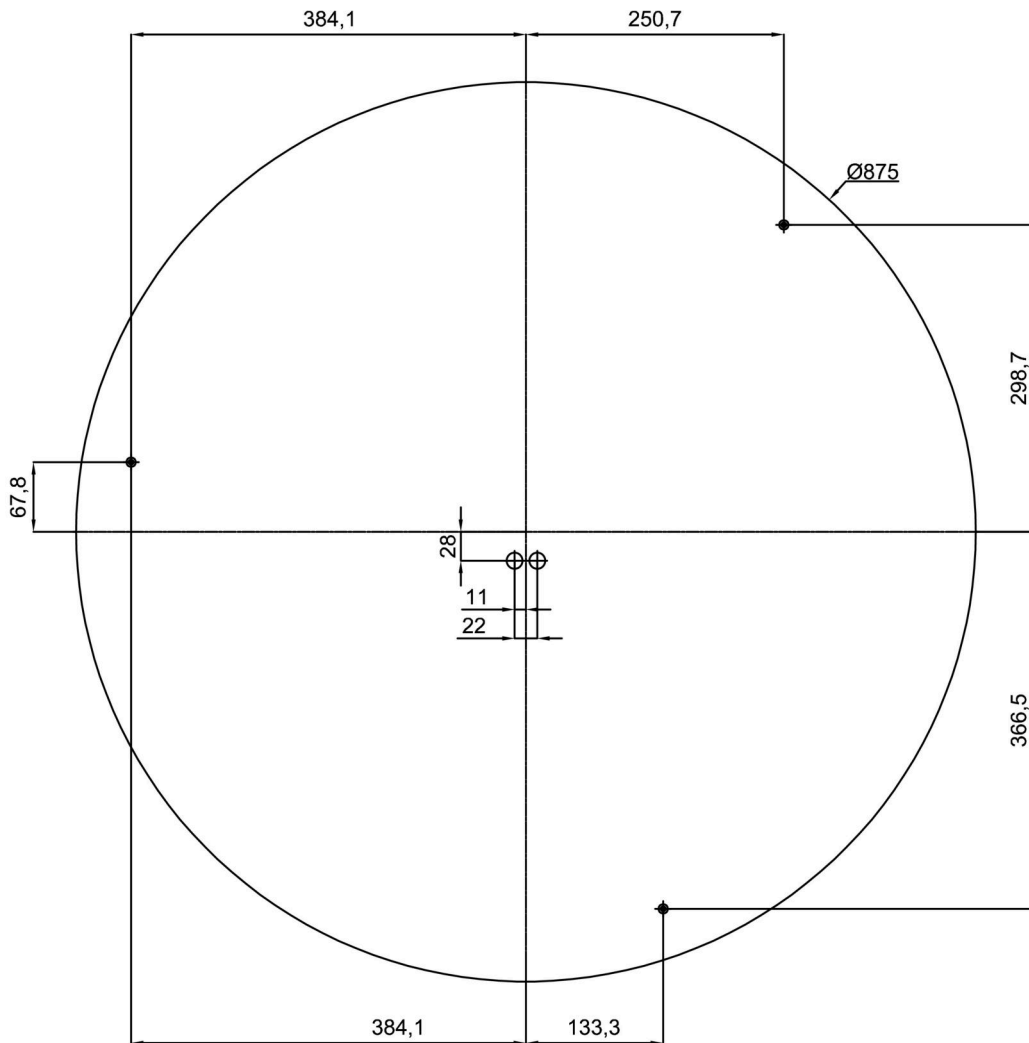

Additional assortment:

Lampshade

Product code	Name	Color	Picture	Drawing
20655	PC26	white	