

CORVUS LE1

LED-1L17E700ZLEN73/PC42/L100 B DALI 3K#

WWW.OSMONT.CZ

CORVUS LE1

Product code: COR72301

Type: LED-1L17E700ZLEN73/PC42/L100 B DALI 3K#

Short description of the luminaire: White pendant LED light DALI and polycarbonate shade.



Technical

Types of luminaires	Dimmable
Mounting type	Suspended - SELV wire (cableless)
Base material	steel
Shade material	opal polycarbonate
Base color	white Ral9003
Shade color	white
Holding the shade	folding system
Mounting location	ceiling
Width	370 mm
Length	370 mm
Height	55 mm
Diameter	Ø 370 mm
Hinge length	1000 mm
mounting holes (diameter)	3xØ5mm
Installation wire (diameter)	2xØ16mm
Energy Class	D
Impact strength	IK10
Operating temperature	from -20°C to +30°C

Electric

Power consumption	25 W
Ingress Protection	IP40
Socket	LED modul
terminal block	snap terminal block
Automatic circuit breaker type B10A	31 pcs
Automatic circuit breaker type B16A	50 pcs
Automatic circuit breaker type C10A	52 pcs
Automatic circuit breaker type C16A	85 pcs

Luminous

Lum. flux of luminaire	2380 lm
Lum. flux of light source	3770 lm
Luminaire efficacy	95 lm/W
Temperature	3000 K
Rated life time LED L80/B10	100000 hours
CRI	Ra80
MacAdam	3
Blue light hazard	Risk group 0

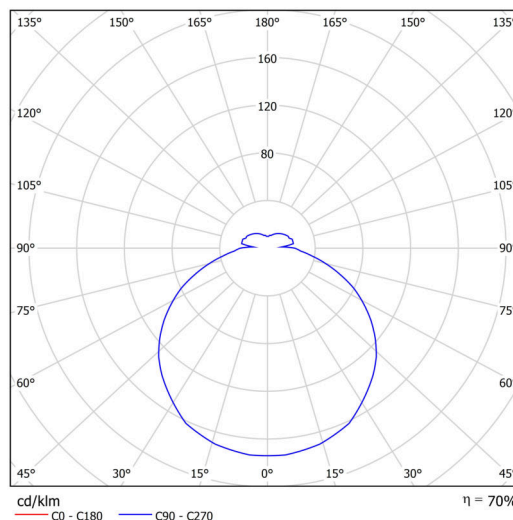
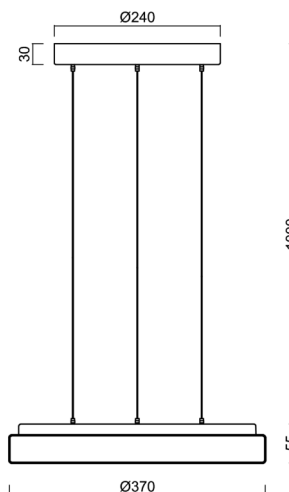
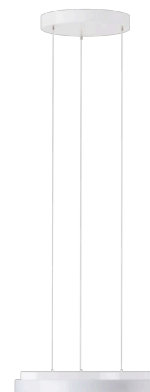

Eulum data for calculation programs are available at www.osmont.cz.

Logistic

EAN	8591728072445
Weight NTTO	3.12 Kg
Weight BTTO	3.52 Kg
Number of cartons	1 pcs
Package volume	0.38 m ³
Package 1 width	0.38 m
Package 1 length	0.22 m
Package 1 height	0.22 m
Warranty*	60 months

*The warranty for the batteries is valid for 12 months from the date of purchase.

Installation dimensions:

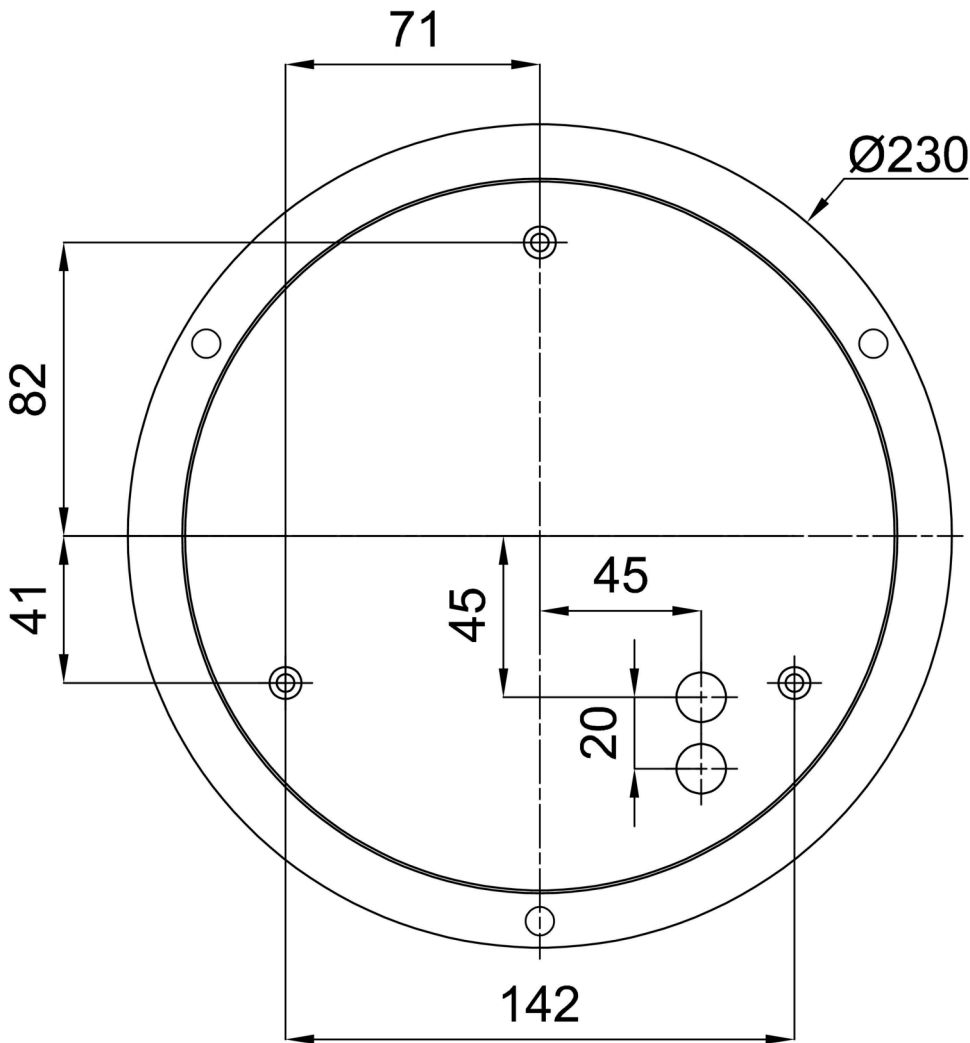

Additional assortment:

Lampshade

Product code	Name	Color	Description	Picture	Drawing
20613	PC42	white		