

CITADELA LE2

Private: LED-1L20E1000ZLEN96/426/L100/SL540K B DALI 3K##

WWW.OSMONT.CZ

CITADELA LE2

Product code: CIT50027

Type: Private: LED-1L20E1000ZLEN96/426/L100/SL540K B DALI 3K##

Short description of the luminaire: White colour | pendant LED light DALI | TRIPLEX OPAL hand blown glass shade with decorative crystal collar (transparent) | steel wire pendant (SELV, cableless) 100 cm |



Technical data

Types of luminaires	Dimmable
Mounting type	Suspended - SELV wire (cableless)
Base material	steel
Shade material	three-layer glass TRIPLEX OPAL
Base color	white Ral9003
Shade color	white
Holding the shade	folding system
Mounting location	ceiling
Width	540 mm
Length	540 mm
Height	70 mm
Diameter	ø 540 mm
Suspension length	1000 mm
mounting holes (diameter)	2xø5mm
Cable entrance	2xø16mm
Impact strength	IK01
Operating temperature	from -20°C to +30°C

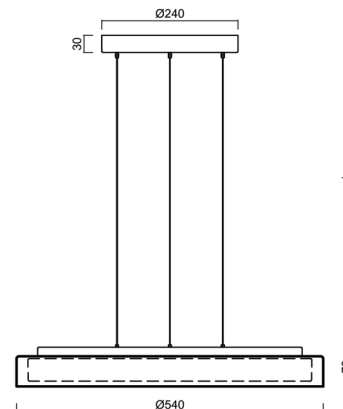
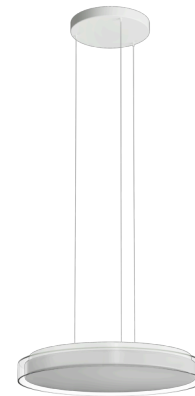

Electrical data

Power consumption	46 W
Ingress Protection	IP40
Socket	LED modul
terminal block	snap terminal block

Luminous data

Lum. flux of luminaire	4800 lm
Lum. flux of light source	7380 lm
Chromaticity temperature	3000 K
Rated life time LED L80/B10	100000 hours
CRI	Ra80
MacAdam	3
Blue light hazard	Risk group 0

Eulum data for calculation programs are available at www.osmont.cz.

Logistical data

EAN	8591728228637
Weight NTTO	5.4 Kg

TECHNICAL SHEET



Weight BTTO	6.4 Kg
Warranty*	60 months

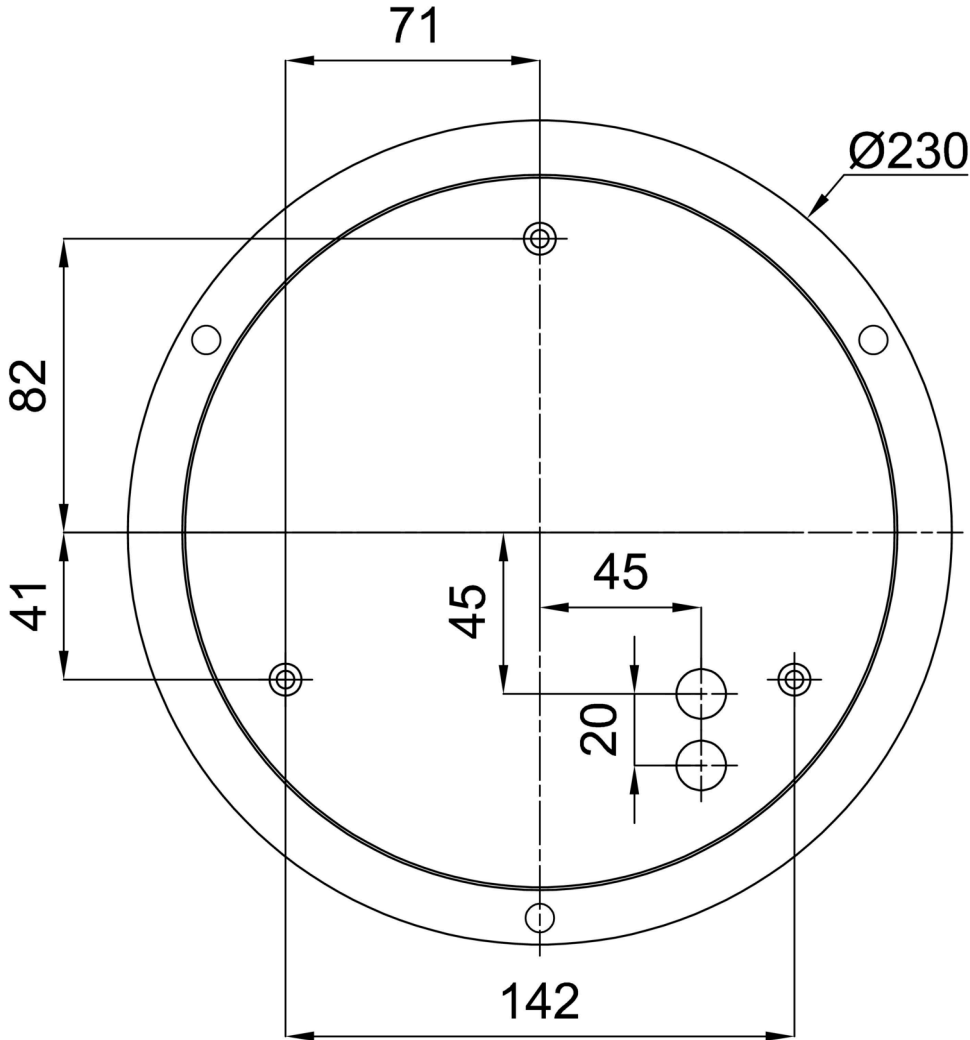

*The warranty for the batteries is valid for 36 months from the date of purchase.

Installation dimensions:



Additional assortment:

Decorative collar

Product code	Name	Color	Picture	Drawing
30185	SL540C			
30184	SL540K			
30186	SL540H			

Lampshade

Product code	Name	Color	Picture	Drawing
20116	426	white		