

CITADELA LE1

Private: LED-1L17E700ZLEN76/425/L100/SL420K B DALI 3K#

WWW.OSMONT.CZ

CITADELA LE1

Product code: CIT50019

Type: Private: LED-1L17E700ZLEN76/425/L100/SL420K B DALI 3K#

Short description of the luminaire: White colour | pendant LED light DALI | TRIPLEX OPAL hand blown glass shade with decorative crystal collar (transparent) | steel wire pendant (SELV, cableless) 100 cm |

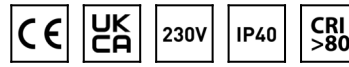

Technical data

Types of luminaires	Dimmable
Mounting type	Suspended - SELV wire (cableless)
Base material	steel
Shade material	three-layer glass TRIPLEX OPAL
Base color	white Ral9003
Shade color	white
Holding the shade	folding system
Mounting location	ceiling
Width	420 mm
Length	420 mm
Height	70 mm
Diameter	ø 420 mm
Suspension length	1000 mm
mounting holes (diameter)	2xø5mm
Cable entrance	2xø16mm
Impact strength	IK01
Operating temperature	from -20°C to +30°C

Electrical data

Power consumption	25 W
Ingress Protection	IP40
Socket	LED modul
terminal block	snap terminal block

Luminous data

Lum. flux of luminaire	2380 lm
Lum. flux of light source	3770 lm
Chromaticity temperature	3000 K
Rated life time LED L80/B10	100000 hours
CRI	Ra80
MacAdam	3
Blue light hazard	Risk group 0

Eulum data for calculation programs are available at www.osmont.cz.

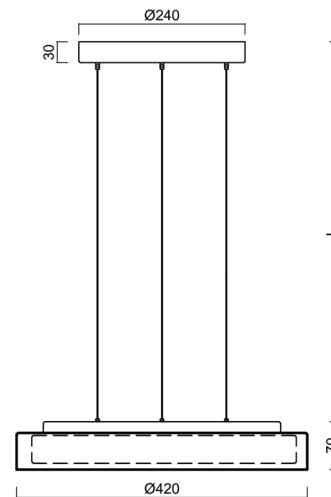
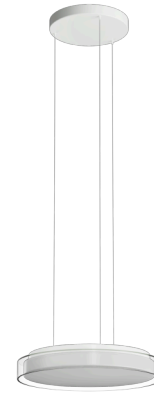

Logistical data

EAN	8591728228552
Weight NTTO	4.9 Kg

TECHNICAL SHEET



Weight BTTO	5.2 Kg
Warranty*	60 months

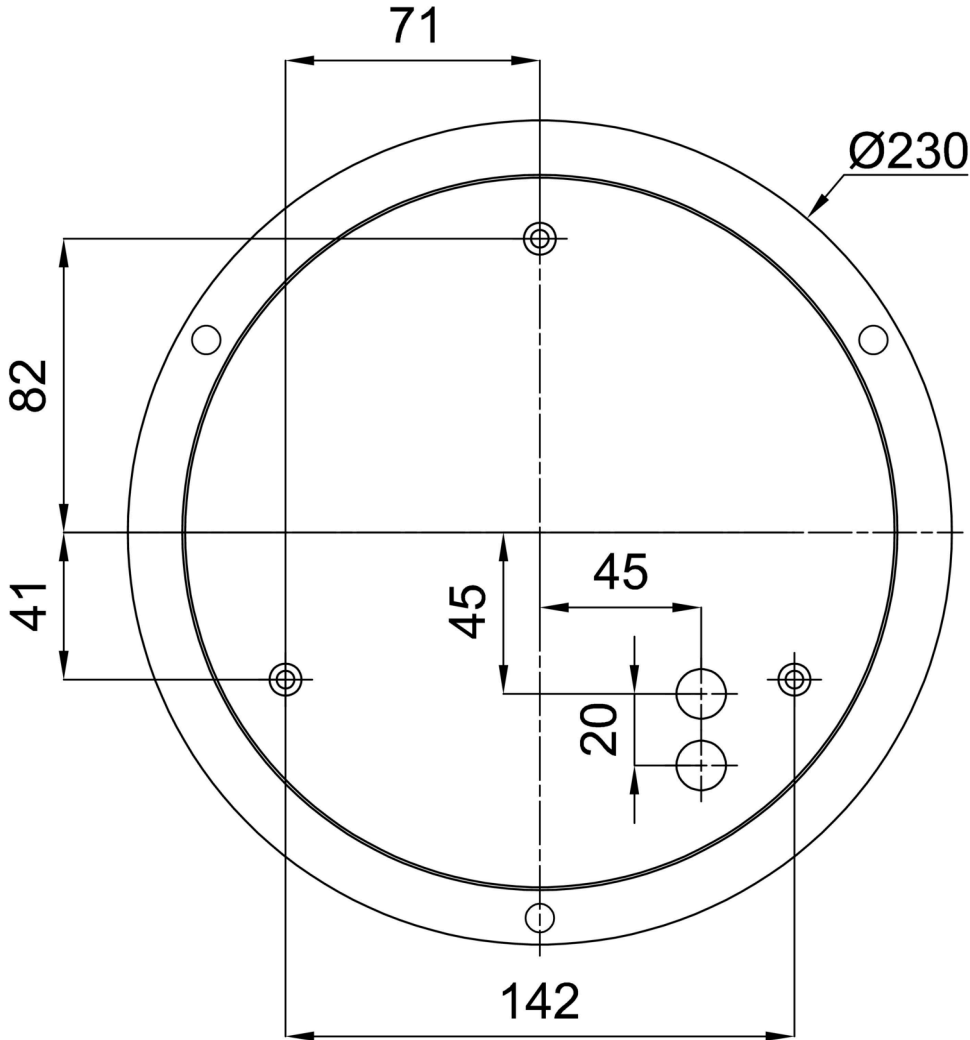

*The warranty for the batteries is valid for 36 months from the date of purchase.

Installation dimensions:



Additional assortment:

Decorative collar

Product code	Name	Color	Picture	Drawing
30183	SL420H			
30182	SL420C			
30181	SL420K			

Lampshade

Product code	Name	Color	Picture	Drawing
20130	425	white	