



CITADELA 2

LED-1L20EX700KN96/426/SL540K B DALI 4K##

WWW.OSMONT.CZ

CITADELA 2

Product code: CIT50507

Type: LED-1L20EX700KN96/426/SL540K B DALI 4K##

Short description of the luminaire: White colour | ceiling or wall LED light DALI | TRIPLEX OPAL hand blown glass shade with decorative crystal collar (transparent)



Technical data

Types of luminaires	Dimmable
Mounting type	surface mounted
Base material	steel
Shade material	three-layer glass TRIPLEX OPAL
Base color	white Ral9003
Shade color	white
Holding the shade	folding system
Mounting location	ceiling
Width	540 mm
Length	540 mm
Height	70 mm
Diameter	ø 540 mm
mounting holes (diameter)	2xø5mm
Cable entrance	2xø16mm
Energy Class	D
Impact strength	IK01
Operating temperature	from -20°C to +30°C

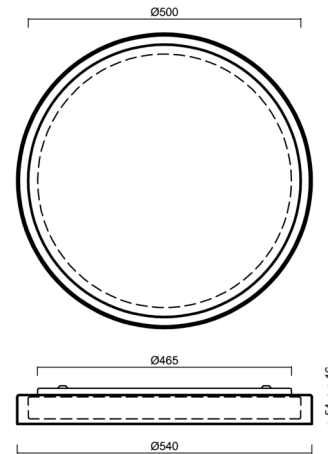

Electrical data

Power consumption	32 W
Ingress Protection	IP44
Socket	LED modul
terminal block	snap terminal block

Luminous data

Lum. flux of luminaire	3650 lm
Lum. flux of light source	5610 lm
Chromaticity temperature	4000 K
Rated life time LED L80/B10	100000 hours
CRI	Ra80
MacAdam	3
Blue light hazard	Risk group 0

Eulum data for calculation programs are available at www.osmont.cz.

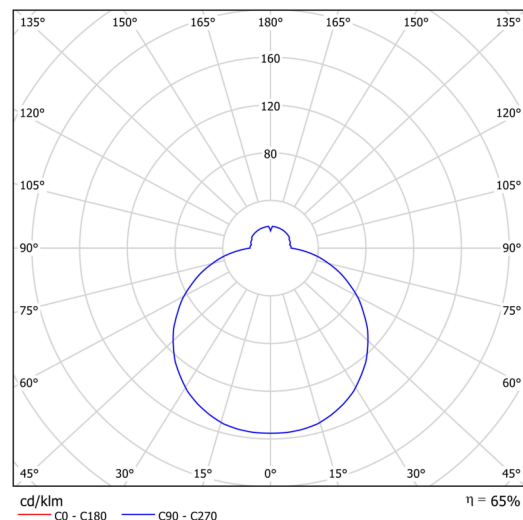

TECHNICAL SHEET



Logistical data

EAN	8591728228798
Weight NTTO	4.1 Kg
Weight BTTO	4.3 Kg
Number of cartons	1 pcs
Warranty*	60 months

*The warranty for the batteries is valid for 36 months from the date of purchase.

Installation dimensions:

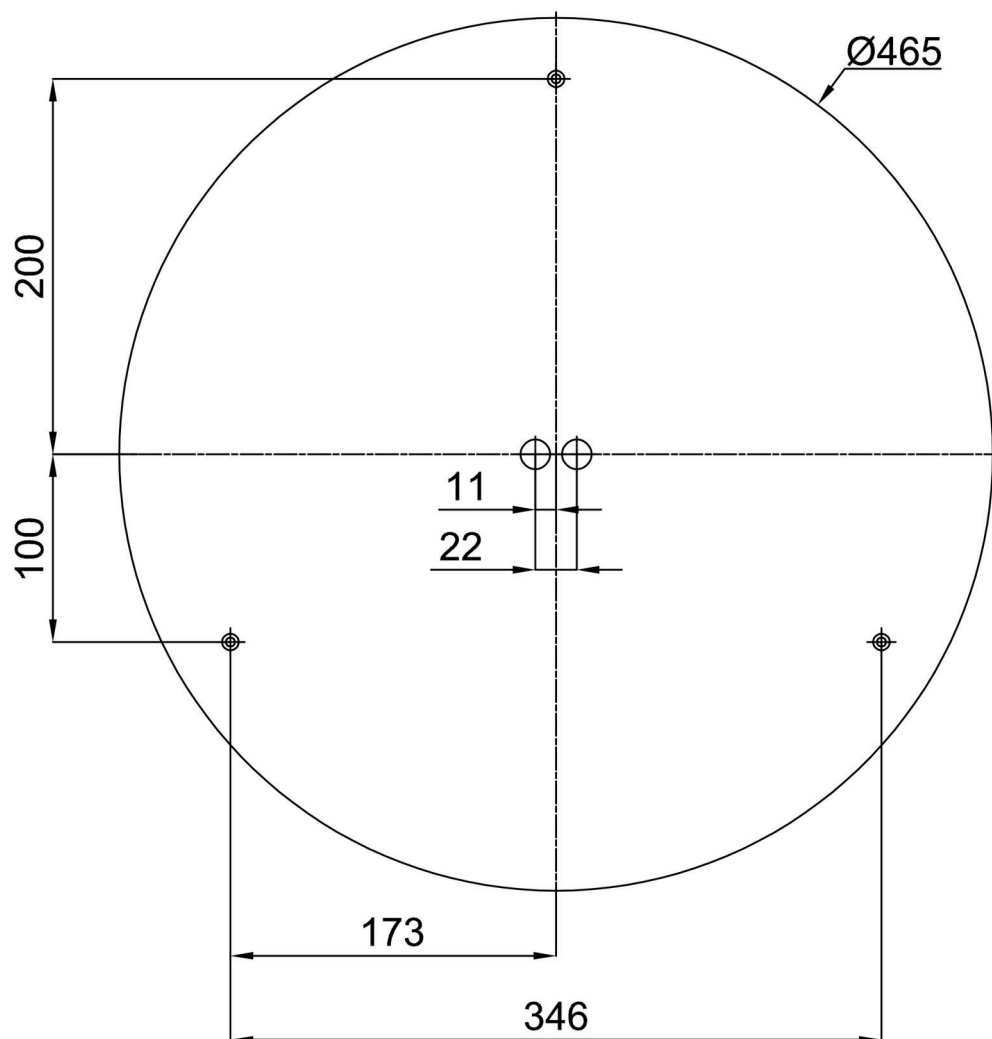

Additional assortment:

Decorative collar

Product code	Name	Color	Picture	Drawing
30186	SL540H			
30185	SL540C			
30184	SL540K			

Lampshade

Product code	Name	Color	Picture	Drawing
20116	426	white		