



AURA P5

LED-1L16E500ZK86/082/z2 4K#

WWW.OSMONT.CZ

AURA P5

Product code: AUR60991

Type: LED-1L16E500ZK86/082/z2 4K#

Short description of the luminaire: White pendant LED light ON/OFF with TRIPLEX OPAL glass shade.



Technical

Types of luminaires	Classic on/off
Mounting type	Suspended - rod
Base material	steel
Shade material	three-layer glass TRIPLEX OPAL
Base color	white Ral9003
Shade color	white
Holding the shade	folding system
Mounting location	ceiling
Width	490 mm
Length	490 mm
Height	140 mm
Diameter	ø 490 mm
Hinge length	400 mm
mounting holes (diameter)	2xø5mm
Installation wire (diameter)	2xø16mm
Energy Class	D
Impact strength	IK01
Operating temperature	from -20°C to +30°C

Electric

Power consumption	24 W
Ingress Protection	IP40
Socket	LED modul
terminal block	screw terminal block
Automatic circuit breaker type B10A	37 pcs
Automatic circuit breaker type B16A	59 pcs
Automatic circuit breaker type C10A	37 pcs
Automatic circuit breaker type C16A	59 pcs

Luminous

Lum. flux of luminaire	2580 lm
Lum. flux of light source	3910 lm
Luminaire efficacy	107 lm/W
Temperature	4000 K
Rated life time LED L80/B10	100000 hours
CRI	Ra80
MacAdam	3
Blue light hazard	Risk group 0

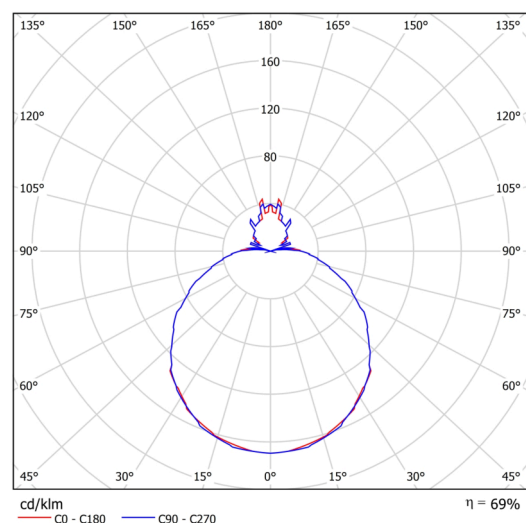
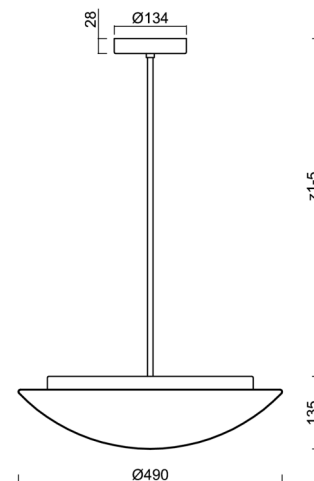

Eulum data for calculation programs are available at www.osmont.cz.

Logistic

EAN	8591728068950
Weight NTTO	5 Kg
Weight BTTO	5.5 Kg
Number of cartons	2 pcs
Package volume	0.052 m ³
Package 1 width	0.515 m
Package 1 length	0.495 m
Package 1 height	0.14 m
Warranty*	60 months

*The warranty for the batteries is valid for 12 months from the date of purchase.

Installation dimensions:

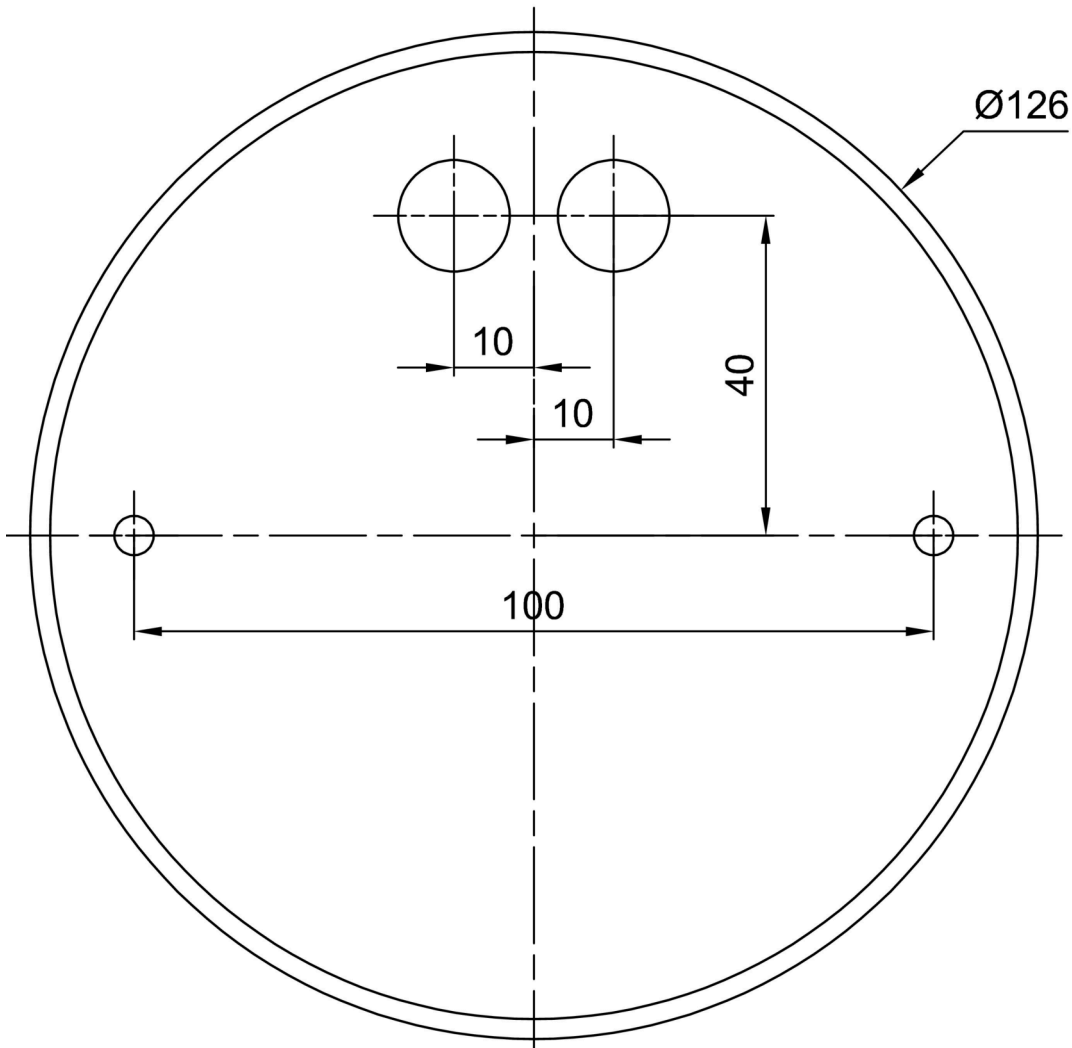

Additional assortment:

Lampshade

Product code	Name	Color	Description	Picture	Drawing
20005	082	white		