

AURA LE9

LED-1L23E700ZLE98/084/L100 B DALI 4K##

WWW.OSMONT.CZ

AURA LE9

Product code: AUR73562

Type: LED-1L23E700ZLE98/084/L100 B DALI 4K##

Short description of the luminaire: White color | pendant LED light | dimmable DALI | TRIPLEX OPAL glass shade with matt surface



Technical

Types of luminaires	Dimmable
Mounting type	Suspended - SELV wire (cableless)
Base material	steel
Shade material	three-layer glass TRIPLEX OPAL
Base color	white Ra9003
Shade color	white
Holding the shade	folding system
Mounting location	ceiling
Width	590 mm
Length	590 mm
Height	140 mm
Diameter	ø 590 mm
Hinge length	1000 mm
mounting holes (diameter)	3xø5mm
Installation wire (diameter)	2xø16mm
Energy Class	D
Impact strength	IK01
Operating temperature	from -20°C to +30°C

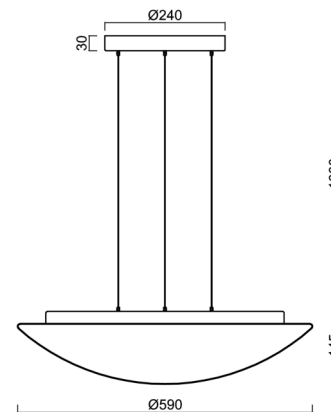
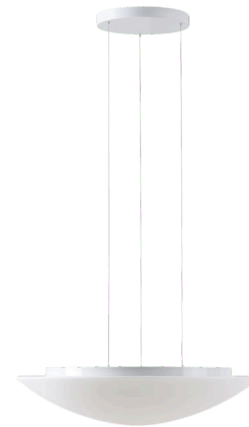

Electric

Power consumption	35 W
Ingress Protection	IP40
Socket	LED modul
terminal block	snap terminal block
Automatic circuit breaker type B10A	31 pcs
Automatic circuit breaker type B16A	50 pcs
Automatic circuit breaker type C10A	52 pcs
Automatic circuit breaker type C16A	85 pcs

Luminous

Lum. flux of luminaire	3800 lm
Lum. flux of light source	5850 lm
Luminaire efficacy	108 lm/W
Temperature	4000 K
Rated life time LED L80/B10	100000 hours
CRI	Ra80
MacAdam	3
Blue light hazard	Risk group 0

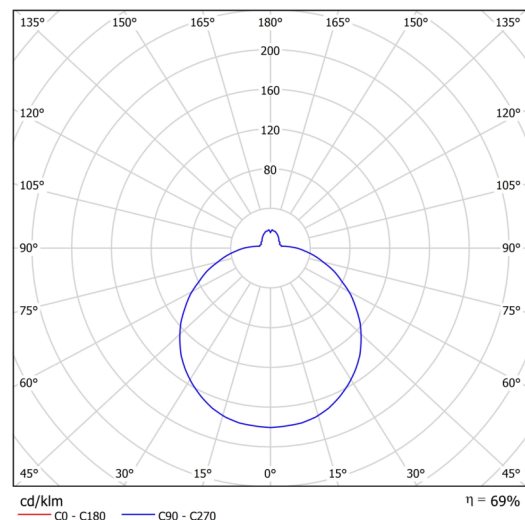

TECHNICAL SHEET



Eulum data for calculation programs are available at www.osmont.cz.

Logistic

EAN	8591728072223
Weight NTTO	7.5 Kg
Weight BTTO	8.3 Kg
Number of cartons	2 pcs
Package volume	0.094 m ³
Package 1 width	0.625 m
Package 1 length	0.625 m
Package 1 height	0.15 m
Warranty*	60 months

*The warranty for the batteries is valid for 12 months from the date of purchase.

Installation dimensions:

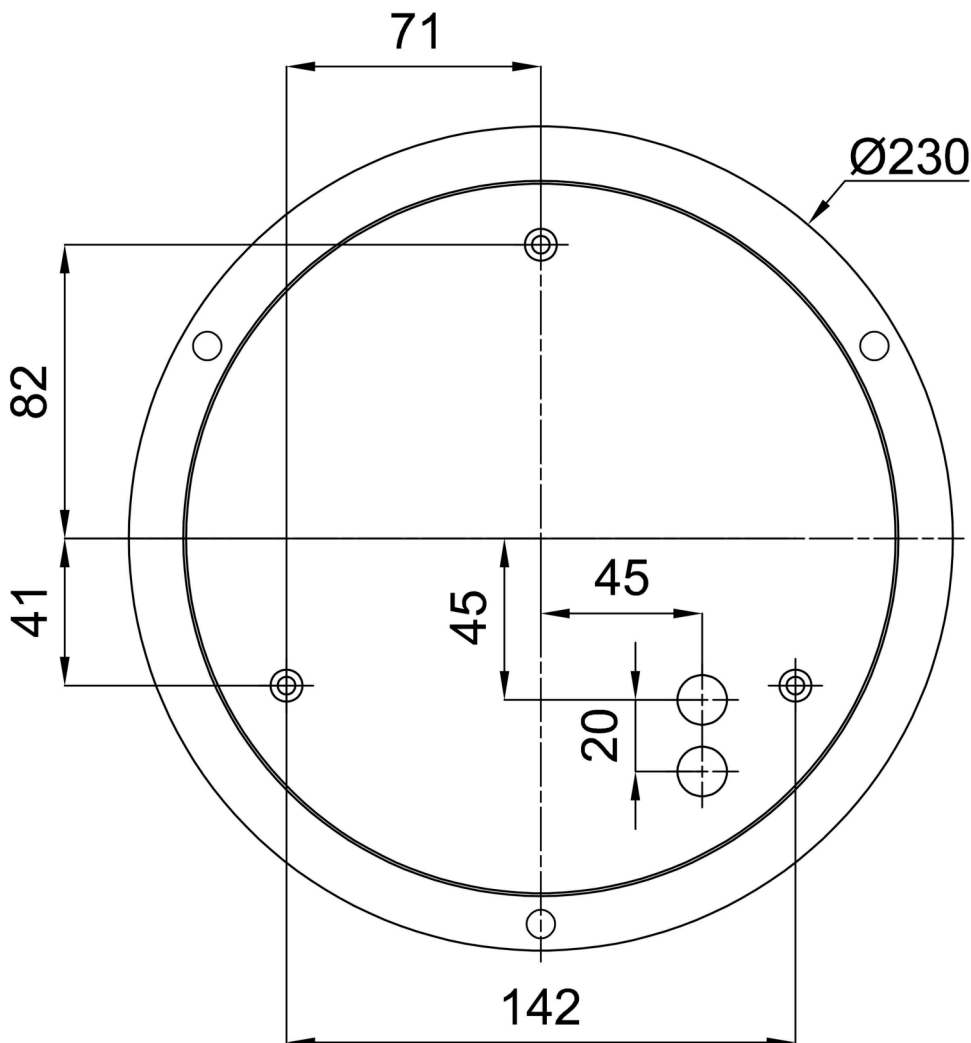

Additional assortment:

Lampshade

Product code	Name	Color	Description	Picture	Drawing
20050	084	white		