



## AURA 8

---

LED-1L14E500BT13/013 DALI 4K#

[WWW.OSMONT.CZ](http://WWW.OSMONT.CZ)

# AURA 8

Product code: AUR59942

Type: LED-1L14E500BT13/013 DALI 4K#

Short description of the luminaire: White surface-mounted LED light DALI with TRIPLEX OPAL glass shade.



## Technical

Types of luminaires	Dimmable
Mounting type	surface mounted
Base material	steel
Shade material	three-layer glass TRIPLEX OPAL
Base color	white Ral9003
Shade color	white
Holding the shade	bayonet
Mounting location	ceiling/wall
Width	300 mm
Length	300 mm
Height	115 mm
Diameter	ø 300 mm
mounting holes (diameter)	3xø5mm
Installation wire (diameter)	2xø16mm
Energy Class	D
Impact strength	IK01
Operating temperature	from -20°C to +30°C

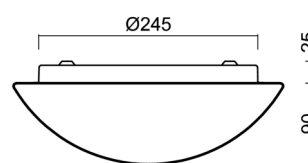
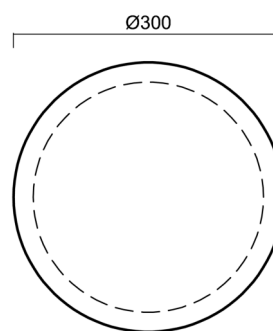

## Electric

Power consumption	13 W
Ingress Protection	IP44
Socket	LED modul
terminal block	snap terminal block
Automatic circuit breaker type B10A	31 pcs
Automatic circuit breaker type B16A	50 pcs
Automatic circuit breaker type C10A	52 pcs
Automatic circuit breaker type C16A	85 pcs

## Luminous

Lum. flux of luminaire	1350 lm
Lum. flux of light source	2080 lm
Luminaire efficacy	103 lm/W
Temperature	4000 K
Rated life time LED L80/B10	100000 hours
CRI	Ra80
MacAdam	3
Blue light hazard	Risk group 0

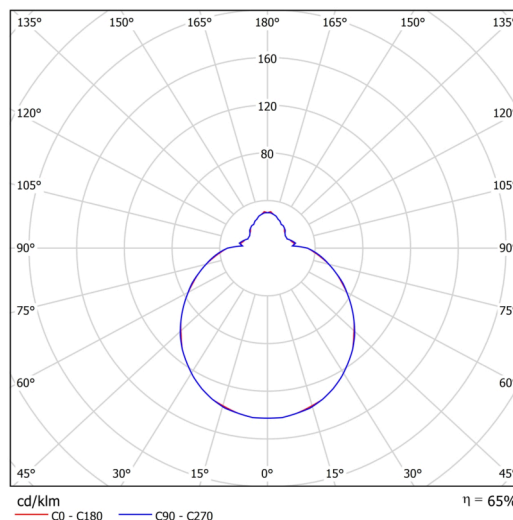

Eulum data for calculation programs are available at [www.osmont.cz](http://www.osmont.cz).

Logistic

EAN	8591728068219
Weight NTTO	1.7 Kg
Weight BTTO	1.9 Kg
Number of cartons	1 pcs
Package volume	0.012 m <sup>3</sup>
Package 1 width	0.32 m
Package 1 length	0.31 m
Package 1 height	0.12 m
Warranty*	60 months

\*The warranty for the batteries is valid for 12 months from the date of purchase.

Installation dimensions:

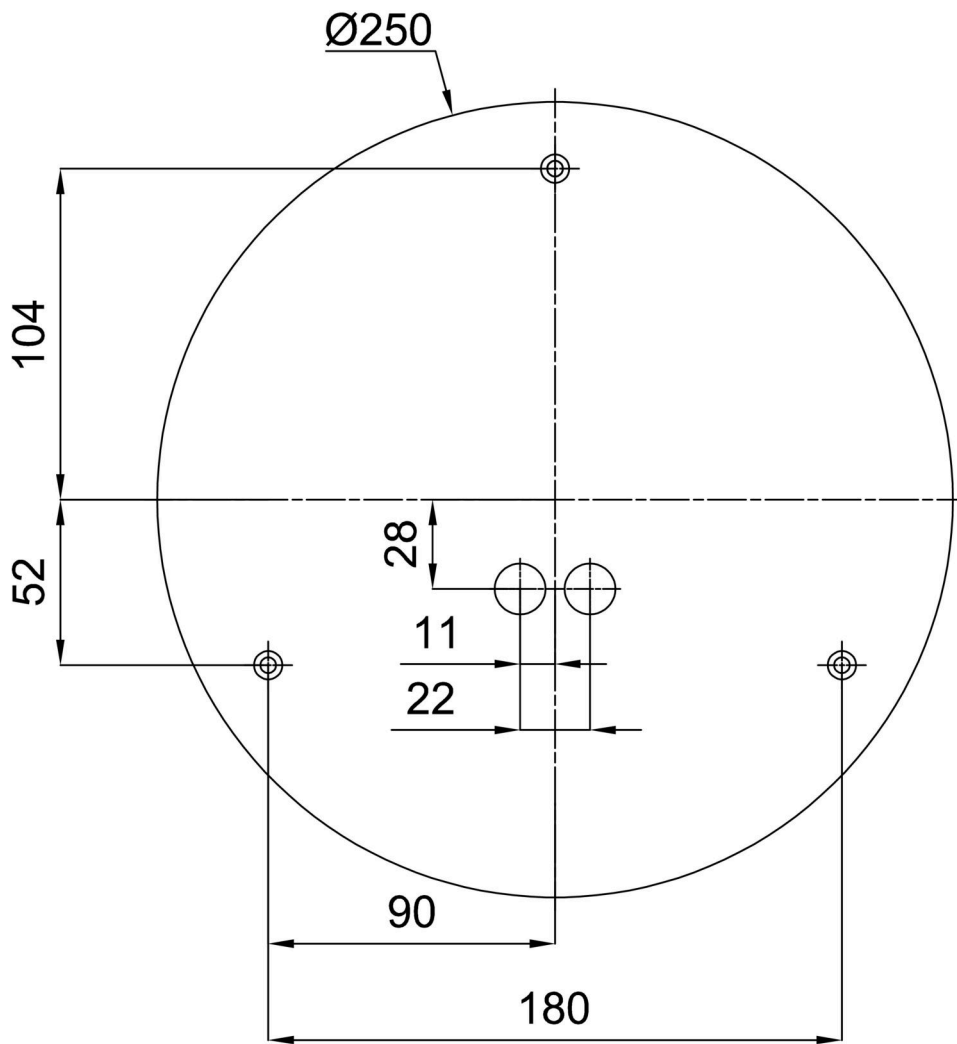

Additional assortment:

Decorative collar

Product code	Name	Color	Description	Picture	Drawing
30069	B13/X14	polished stainless steel	the collar is held by the shade		
30068	B13/X4	white Ral9003	the collar is held by the shade		
30071	B13/X13	grey	the collar is held by the shade		
30070	B13/X12	polished brass	the collar is held by the shade		

Base for surface mounting

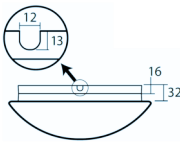
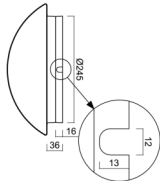
Product code	Name	Color	Description	Picture	Drawing
33504	B13/BP	white Ral9003			

Lampshade

Product code	Name	Color	Description	Picture	Drawing
20008	013	white		