



AURA 4

LED-1L15E700K74/072 DALI 4K#

WWW.OSMONT.CZ

AURA 4

Product code: AUR59527

Type: LED-1L15E700K74/072 DALI 4K#

Short description of the luminaire: White surface-mounted LED light DALI with TRIPLEX OPAL glass shade.



Technical

Types of luminaires	Dimmable
Mounting type	surface mounted
Base material	steel
Shade material	three-layer glass TRIPLEX OPAL
Base color	white Ral9003
Shade color	white
Holding the shade	folding system
Mounting location	ceiling/wall
Width	420 mm
Length	420 mm
Height	125 mm
Diameter	ø 420 mm
mounting holes (diameter)	4xø5mm
Installation wire (diameter)	2xø16mm
Energy Class	D
Impact strength	IK01
Operating temperature	from -20°C to +30°C

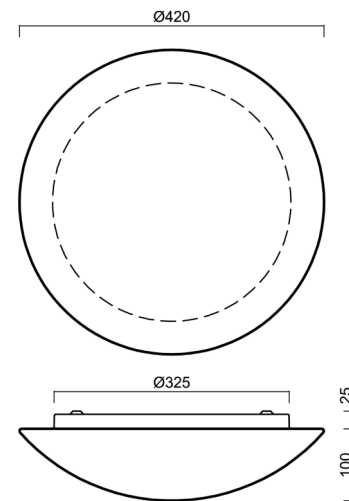

Electric

Power consumption	27 W
Ingress Protection	IP43
Socket	LED modul
terminal block	snap terminal block
Automatic circuit breaker type B10A	31 pcs
Automatic circuit breaker type B16A	50 pcs
Automatic circuit breaker type C10A	52 pcs
Automatic circuit breaker type C16A	85 pcs

Luminous

Lum. flux of luminaire	3120 lm
Lum. flux of light source	4220 lm
Luminaire efficacy	115 lm/W
Temperature	4000 K
Rated life time LED L80/B10	100000 hours
CRI	Ra80
MacAdam	3
Blue light hazard	Risk group 0

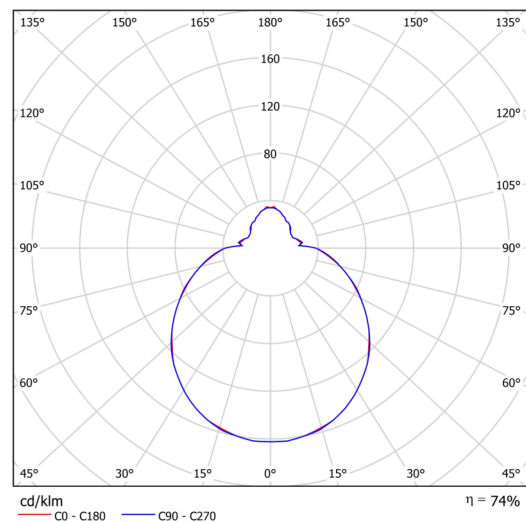

Eulum data for calculation programs are available at www.osmont.cz.

Logistic

EAN	8591728067663
Weight NTTO	2.8 Kg
Weight BTTO	3.1 Kg
Number of cartons	1 pcs
Package volume	0.017 m ³
Package 1 width	0.375 m
Package 1 length	0.355 m
Package 1 height	0.13 m
Warranty*	60 months

*The warranty for the batteries is valid for 12 months from the date of purchase.

Installation dimensions:

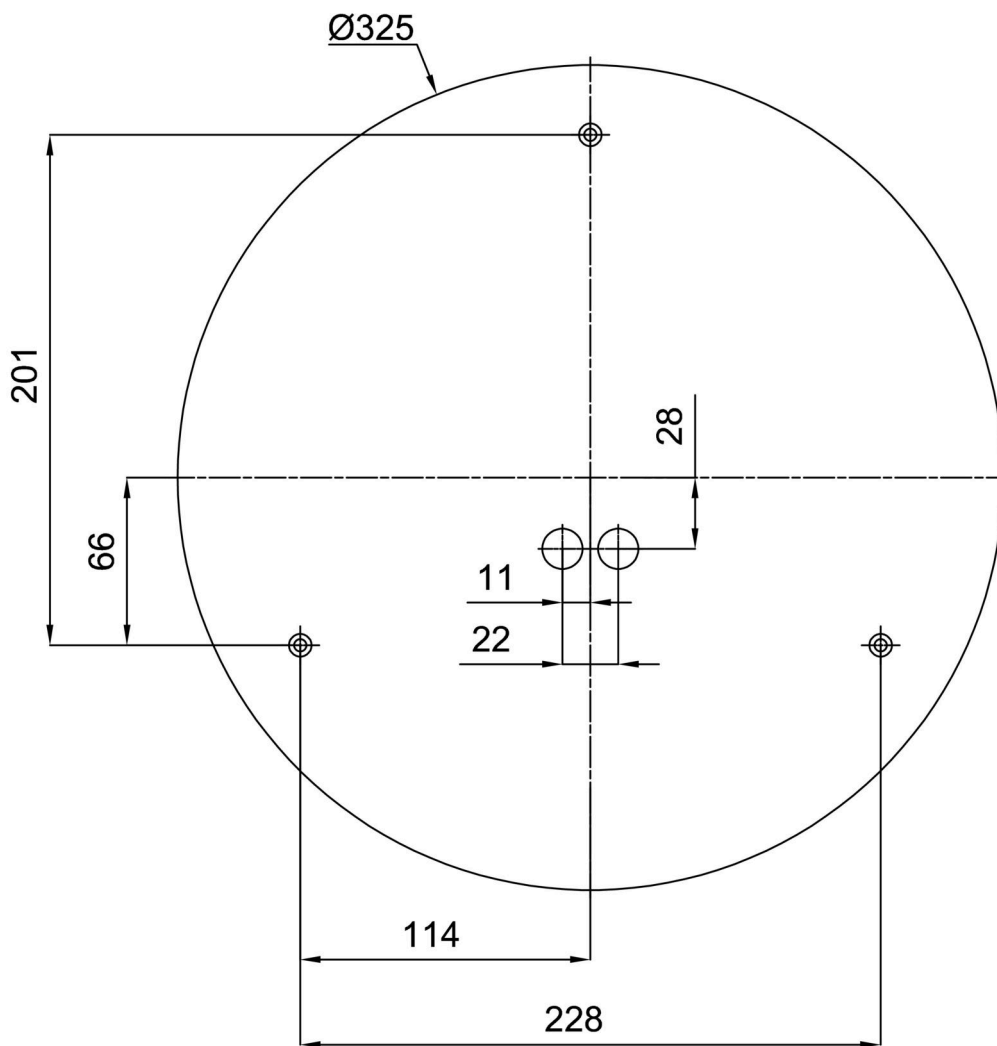

Additional assortment:

Decorative collar

Product code	Name	Color	Description	Picture	Drawing
30131	K74/DL15	brushed stainless steel	the collar is held by the base		
30130	K74/DL14	polished stainless steel	the collar is held by the base		
30129	K74/DL4	white Ral9003	the collar is held by the base		

Lampshade

Product code	Name	Color	Description	Picture	Drawing
20004	072	white		