



## AURA 2

---

LED-1L18E350K53/042 DALI 3K#

[WWW.OSMONT.CZ](http://WWW.OSMONT.CZ)

# AURA 2

Product code: AUR59006

Type: LED-1L18E350K53/042 DALI 3K#

Short description of the luminaire: White surface-mounted LED light DALI with TRIPLEX OPAL glass shade.

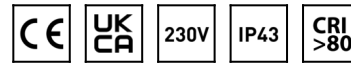

## Technical

|                              |                                |
|------------------------------|--------------------------------|
| Types of luminaires          | Dimmable                       |
| Mounting type                | surface mounted                |
| Base material                | steel                          |
| Shade material               | three-layer glass TRIPLEX OPAL |
| Base color                   | white Ral9003                  |
| Shade color                  | white                          |
| Holding the shade            | folding system                 |
| Mounting location            | ceiling/wall                   |
| Width                        | 280 mm                         |
| Length                       | 280 mm                         |
| Height                       | 120 mm                         |
| Diameter                     | ø 280 mm                       |
| mounting holes (diameter)    | 4xø5mm                         |
| Installation wire (diameter) | 2xø16mm                        |
| Energy Class                 | D                              |
| Impact strength              | IK01                           |
| Operating temperature        | from -20°C to +30°C            |

## Electric

|                                     |                     |
|-------------------------------------|---------------------|
| Power consumption                   | 15 W                |
| Ingress Protection                  | IP43                |
| Socket                              | LED modul           |
| terminal block                      | snap terminal block |
| Automatic circuit breaker type B10A | 31 pcs              |
| Automatic circuit breaker type B16A | 50 pcs              |
| Automatic circuit breaker type C10A | 52 pcs              |
| Automatic circuit breaker type C16A | 85 pcs              |

## Luminous

|                             |              |
|-----------------------------|--------------|
| Lum. flux of luminaire      | 1520 lm      |
| Lum. flux of light source   | 2230 lm      |
| Luminaire efficacy          | 101 lm/W     |
| Temperature                 | 3000 K       |
| Rated life time LED L80/B10 | 100000 hours |
| CRI                         | Ra80         |
| MacAdam                     | 3            |
| Blue light hazard           | Risk group 0 |

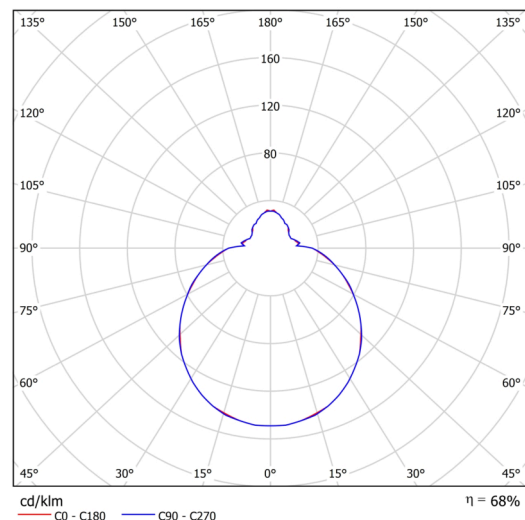
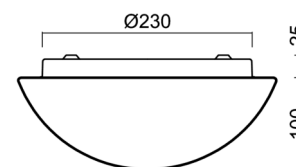
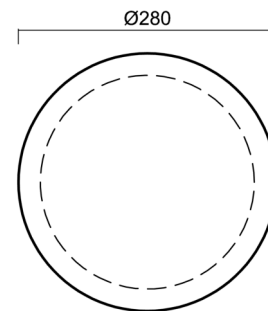

Eulum data for calculation programs are available at [www.osmont.cz](http://www.osmont.cz).

Logistic

|                   |                      |
|-------------------|----------------------|
| EAN               | 8591728066697        |
| Weight NTTO       | 1.7 Kg               |
| Weight BTTO       | 1.9 Kg               |
| Number of cartons | 1 pcs                |
| Package volume    | 0.011 m <sup>3</sup> |
| Package 1 width   | 0.3 m                |
| Package 1 length  | 0.285 m              |
| Package 1 height  | 0.13 m               |
| Warranty*         | 60 months            |

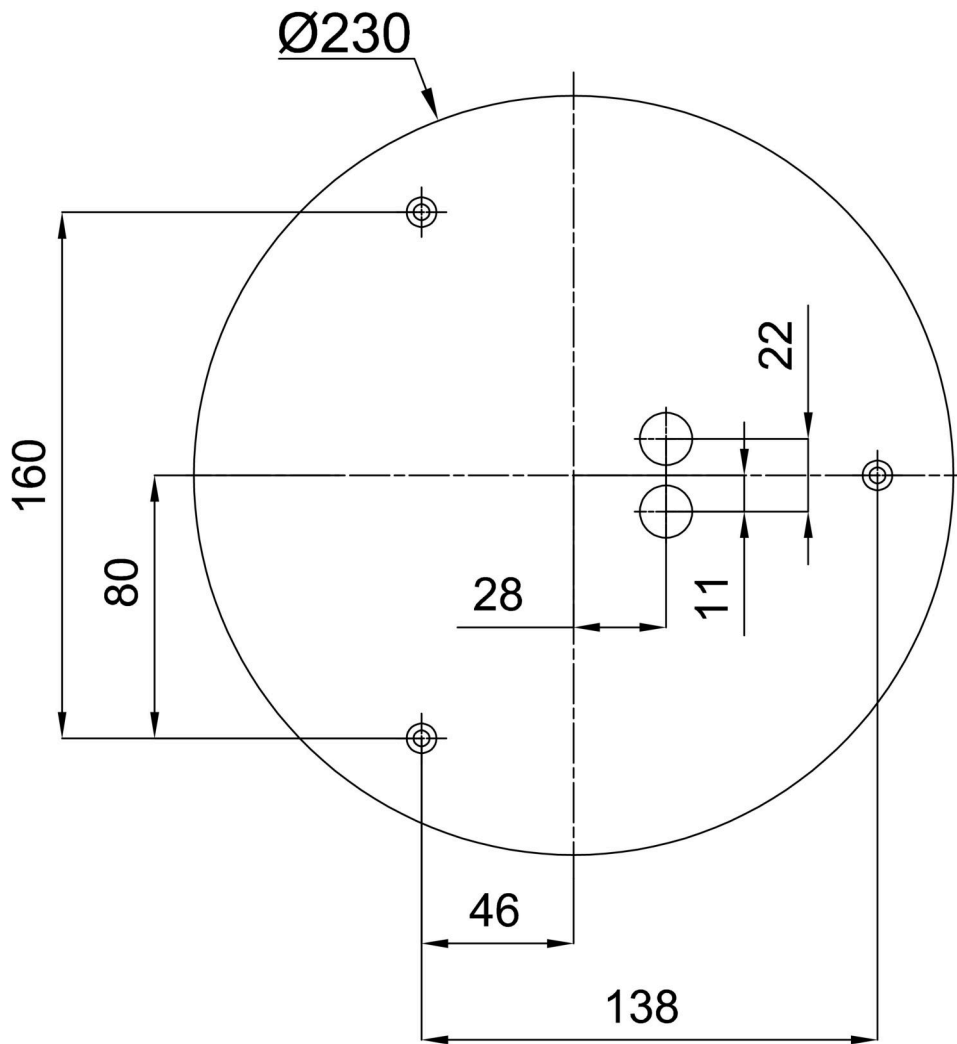

\*The warranty for the batteries is valid for 12 months from the date of purchase.

Installation dimensions:



## Additional assortment:

## Decorative collar

| Product code | Name     | Color                          | Description                    | Picture  | Drawing |
|--------------|----------|--------------------------------|--------------------------------|--|---------|
| 30123        | K52/DL4  | white<br>Ra19003               | the collar is held by the base |  |         |
| 30124        | K52/DL14 | polished<br>stainless<br>steel | the collar is held by the base |  |         |
| 30125        | K52/DL15 | brushed<br>stainless<br>steel  | the collar is held by the base |  |         |

## Lampshade

| Product code | Name | Color | Description | Picture  | Drawing |
|--------------|------|-------|-------------|--|---------|
| 20002        | 042  | white |             |  |         |