



AURA 10

IN-12BT14/014 HF*

WWW.OSMONT.CZ

AURA 10

Product code: AUR42751

Type: IN-12BT14/014 HF*

Short description of the luminaire: White surface-mounted E27 light with sensor with TRIPLEX OPAL glass shade.

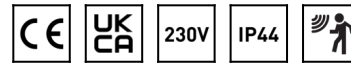

Technical

Types of luminaires	Sensor
Mounting type	surface mounted
Base material	steel
Shade material	three-layer glass TRIPLEX OPAL
Base color	white Ral9003
Shade color	white
Holding the shade	bayonet
Mounting location	ceiling/wall
Width	360 mm
Length	360 mm
Height	125 mm
Diameter	ø 360 mm
mounting holes (diameter)	3xø5mm
Installation wire (diameter)	2xø16mm
Impact strength	IK01
Operating temperature	from -20°C to +30°C

Electric

Voltage type	AC
AC voltage	220 - 240 V
Power consumption	25 W
Ingress Protection	IP44
Socket	E27
Sensor	HF
terminal block	snap terminal block

Luminous

Blue light hazard	Risk group 0
-------------------	--------------

Eulum data for calculation programs are available at www.osmont.cz.

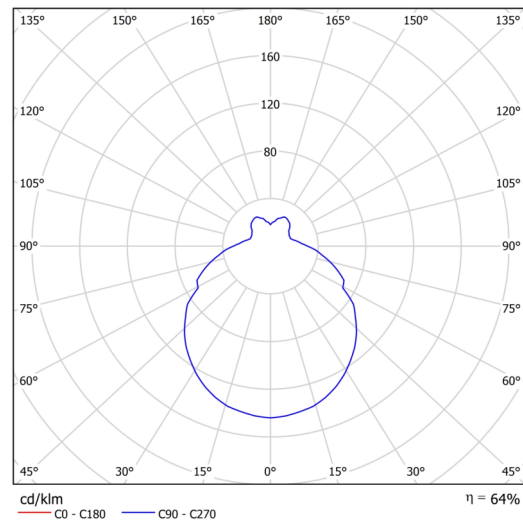
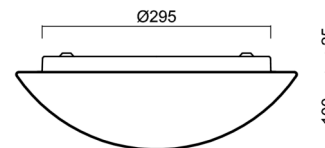
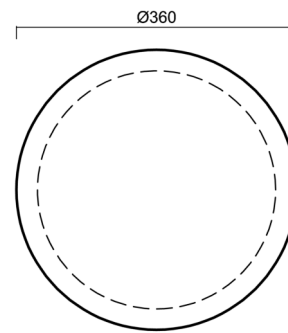

Logistic

EAN	8591728427511
Weight NTTO	1.9 Kg
Weight BTTO	2.2 Kg
Number of cartons	1 pcs
Package volume	0.017 m ³
Package 1 width	0.375 m
Package 1 length	0.355 m
Package 1 height	0.13 m
Warranty*	60 months

*The warranty for the batteries is valid for 12 months from the date of purchase.

Installation dimensions:

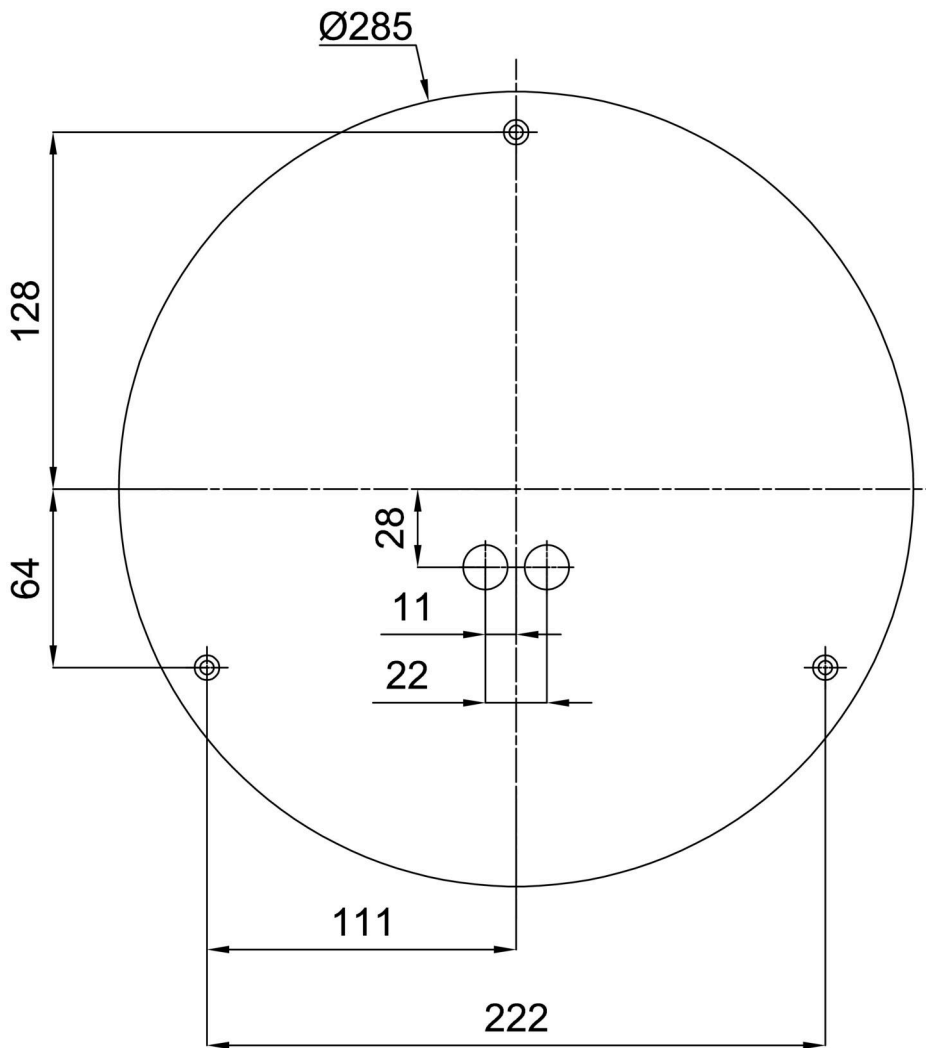

Additional assortment:

Decorative collar

Product code	Name	Color	Description	Picture	Drawing
30136	B14/X14	polished stainless steel	the collar is held by the shade		
30135	B14/X4	white Ral9003	the collar is held by the shade		
30138	B14/X13	grey	the collar is held by the shade		
30137	B14/X12	polished brass	the collar is held by the shade		

Base for surface mounting

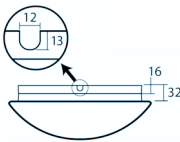
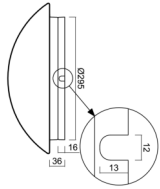
Product code	Name	Color	Description	Picture	Drawing
33505	B14/BP	white Ral9003			

Lampshade

Product code	Name	Color	Description	Picture	Drawing
20055	014	white		