

## ALTAIR 2

---

LED-1L35E700U21/421/NK1W 4K#

[WWW.OSMONT.CZ](http://WWW.OSMONT.CZ)

# ALTAIR 2

Product code: ALT59815

Type: LED-1L35E700U21/421/NK1W 4K#

Short description of the luminaire: White surface-mounted LED light with emergency unit combined with TRIPLEX OPAL glass shade.

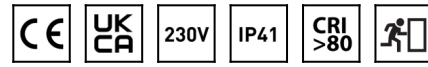

## Technical

Types of luminaires	Emergency combined
Mounting type	surface mounted
Base material	steel
Shade material	three-layer glass TRIPLEX OPAL
Base color	white Ral9003
Shade color	white
Holding the shade	folding system
Mounting location	ceiling/wall
Width	390 mm
Length	362 mm
Height	128 mm
mounting holes (diameter)	4xØ5mm
Installation wire (diameter)	2xØ16mm
Energy Class	D
Impact strength	IK01
Operating temperature	from 0°C to +30°C

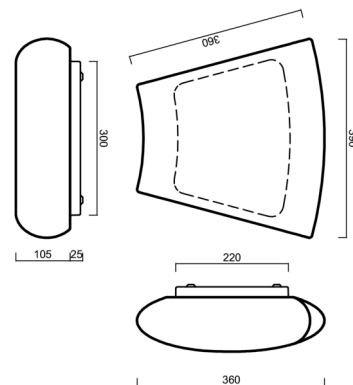

## Electric

Power consumption	19 W
Ingress Protection	IP41
Socket	LED modul
Battery type	NiCd
Emergency time	3 hours
terminal block	snap terminal block
Automatic circuit breaker type B10A	23 pcs
Automatic circuit breaker type B16A	36 pcs
Automatic circuit breaker type C10A	40 pcs
Automatic circuit breaker type C16A	64 pcs

## Luminous

Lum. flux of luminaire	2450 lm
Lum. flux of light source	3220 lm
Lum. flux of light source in emergency mode	150 lm
Luminaire efficacy	128 lm/W
Temperature	4000 K
Rated life time LED L80/B10	100000 hours
CRI	Ra80
MacAdam	3
Blue light hazard	Risk group 0

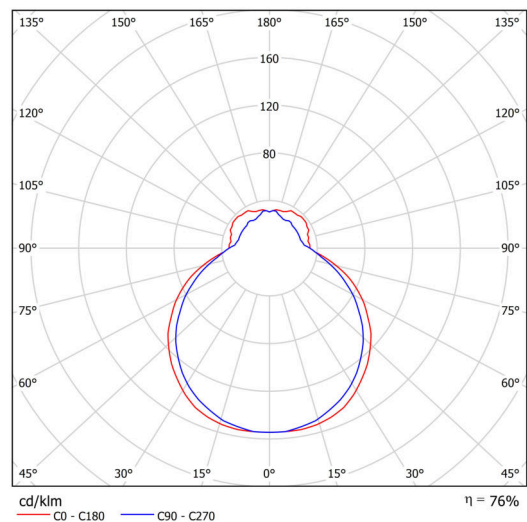

# TECHNICAL SHEET



Eulum data for calculation programs are available at [www.osmont.cz](http://www.osmont.cz).

## Logistic

EAN	8591728063399
Weight NTTO	5.9 Kg
Weight BTTO	6.1 Kg
Number of cartons	1 pcs
Package volume	0.018 m <sup>3</sup>
Package 1 width	0.36 m
Package 1 length	0.36 m
Package 1 height	0.14 m
Warranty*	60 months

\*The warranty for the batteries is valid for 12 months from the date of purchase.

## Installation dimensions:

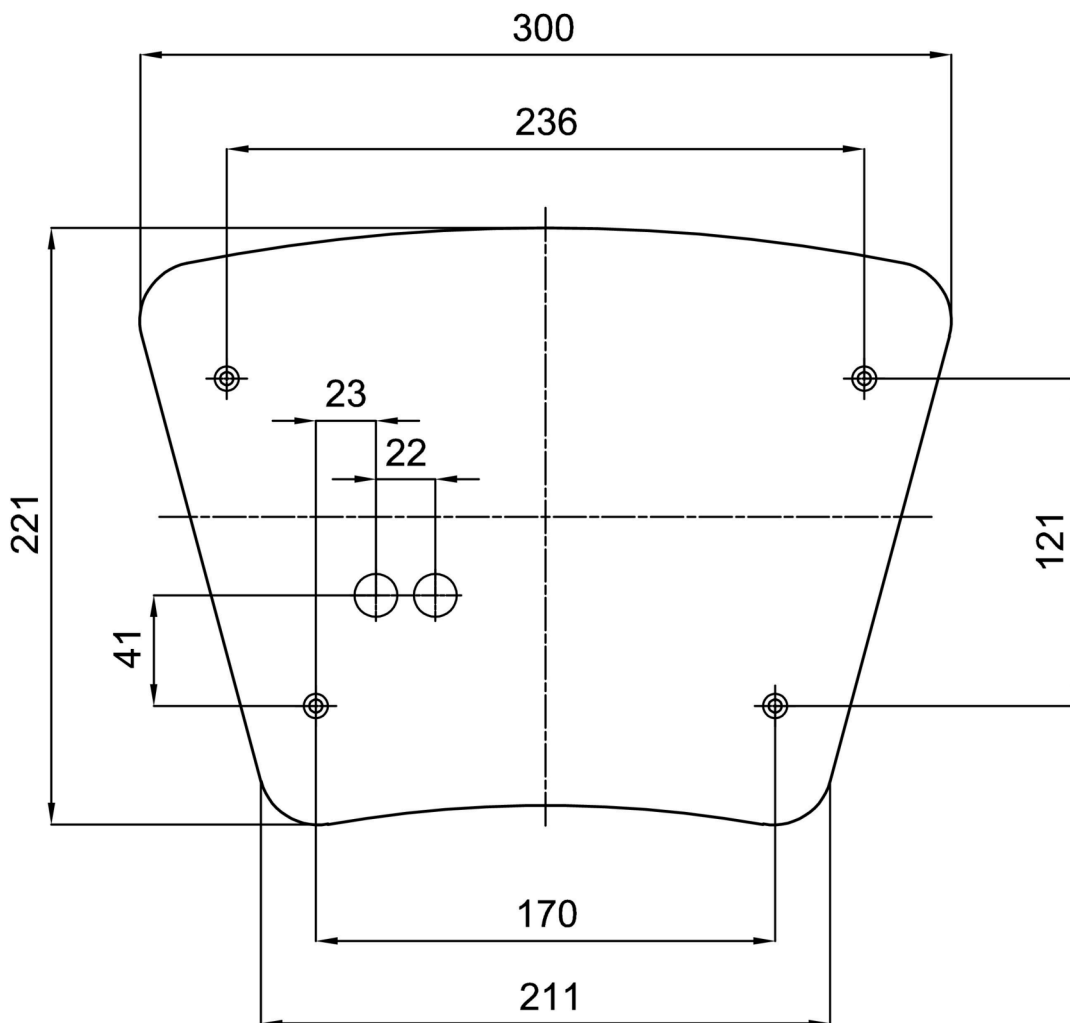

## Additional assortment:

## Lampshade

Product code	Name	Color	Description	Picture	Drawing
20073	421	white		