



## ALKOR D2

---

LED-5L05E600KN02P/406 MS 3K#

[WWW.OSMONT.CZ](http://WWW.OSMONT.CZ)

# ALKOR D2

Product code: ALK67103

Type: LED-5L05E600KN02P/406 MS 3K#

Short description of the luminaire: Brass polished | ceiling or wall LED light ON/OFF | TRIPLEX OPAL hand blown glass shade|



## Technical data

Types of luminaires	Classic on/off
Mounting type	surface mounted
Base material	brass
Shade material	three-layer glass TRIPLEX OPAL
Base color	polished brass
Shade color	white
Holding the shade	folding system
Mounting location	ceiling/wall
Width	140 mm
Length	140 mm
Height	210 mm
Diameter	ø 140 mm
mounting holes (diameter)	3xø5mm
Cable entrance	2xø16mm
Energy Class	D
Impact strength	IK01
Operating temperature	from -20°C to +30°C

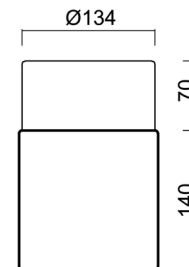

## Electrical data

Power consumption	10 W
Ingress Protection	IP44
Socket	LED modul
terminal block	snap terminal block

## Luminous data

Lum. flux of luminaire	1170 lm
Lum. flux of light source	1460 lm
Chromaticity temperature	3000 K
Rated life time LED L80/B10	100000 hours
CRI	Ra80
MacAdam	3
Blue light hazard	Risk group 0

Eulum data for calculation programs are available at [www.osmont.cz](http://www.osmont.cz).



# TECHNICAL SHEET



## Logistical data

EAN	8591728227982
Number of cartons	1 pcs
Warranty*	60 months

*\*The warranty for the batteries is valid for 36 months from the date of purchase.*

## Installation dimensions:

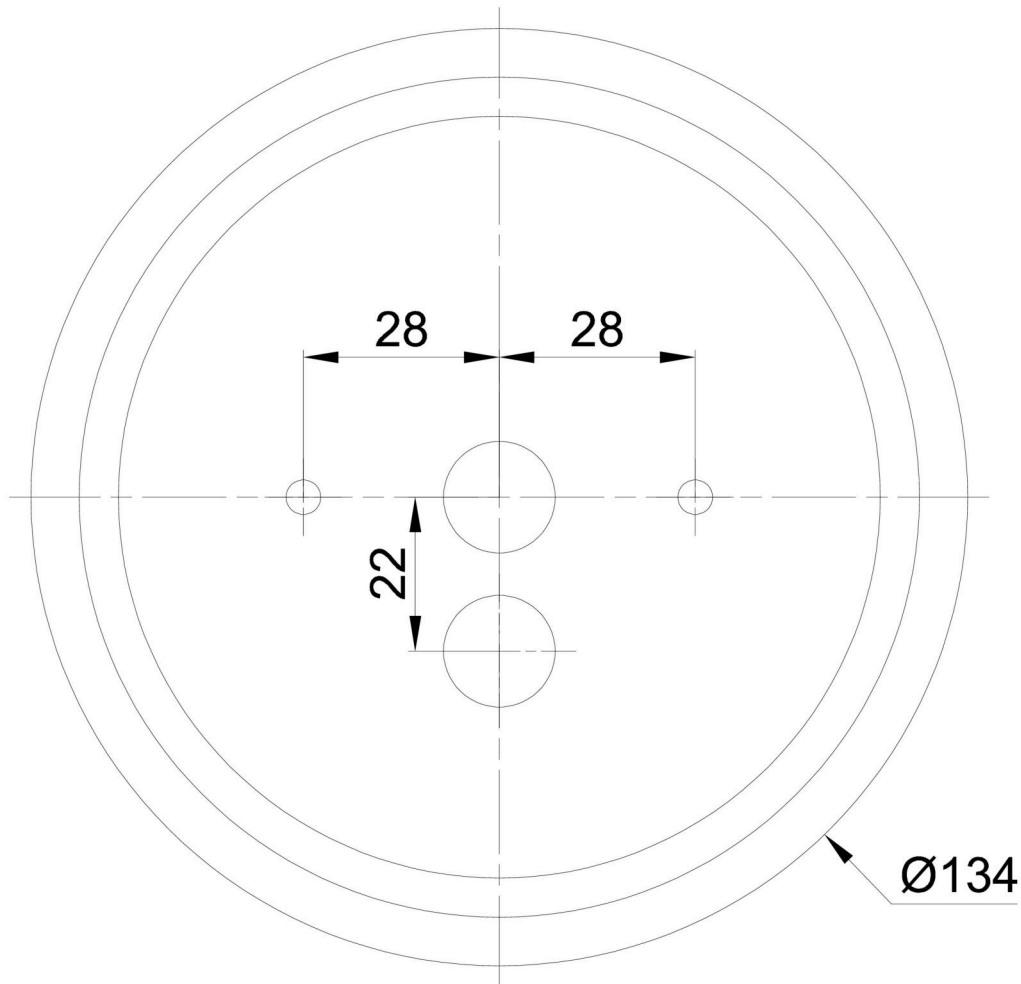

## Additional assortment:

## Lampshade

Product code	Name	Color	Picture	Drawing
20121	406	white	