



ADRIA S3A HP

LED-5L06E900ZS11/097/L100 B DALI 4K#

WWW.OSMONT.CZ

ADRIA S3A HP

Product code: ADR50900

Type: LED-5L06E900ZS11/097/L100 B DALI 4K#

Short description of the luminaire: White colour | pendant high-power LED light DALI | TRIPLEX OPAL hand blown glass shade | cable pendant (with inner support wire) 100 cm |

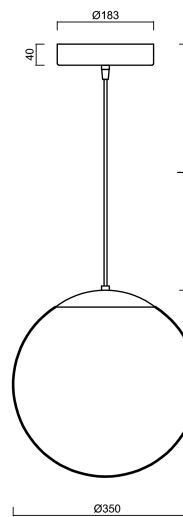

Technical data

Types of luminaires	Dimmable
Mounting type	Suspended - cable
Base material	steel
Shade material	three-layer glass TRIPLEX OPAL
Base color	white Ral9003
Shade color	white
Holding the shade	steel holder
Mounting location	ceiling
Width	350 mm
Length	350 mm
Height	350 mm
Diameter	Ø 350 mm
Suspension length	1000 mm
mounting holes (diameter)	none
Energy Class	D
Impact strength	IK01
Operating temperature	from -20°C to +30°C

Electrical data

Power consumption	43 W
Ingress Protection	IP40
Socket	LED modul
terminal block	none
Automatic circuit breaker type B10A	31 pcs
Automatic circuit breaker type B16A	50 pcs
Automatic circuit breaker type C10A	52 pcs
Automatic circuit breaker type C16A	85 pcs
Switching current	5 A / 50 µsec
Number of LED drivers	1

Luminous data

Lum. flux of luminaire	5870 lm
Lum. flux of light source	6670 lm
Luminaire efficacy	136 lm/W
Chromaticity temperature	4000 K
Rated life time LED L80/B10	100000 hours
CRI	Ra80
MacAdam	3
Blue light hazard	Risk group 0

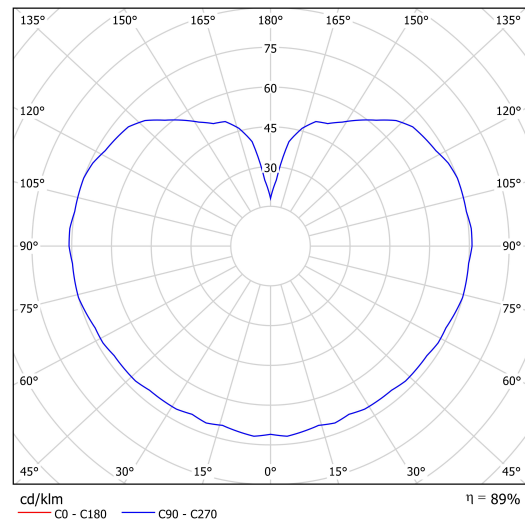

TECHNICAL SHEET



Eulum data for calculation programs are available at www.osmont.cz.

Logistical data

EAN	8591728207656
Warranty*	60 months

*The warranty for the batteries is valid for 36 months from the date of purchase.

Installation dimensions:

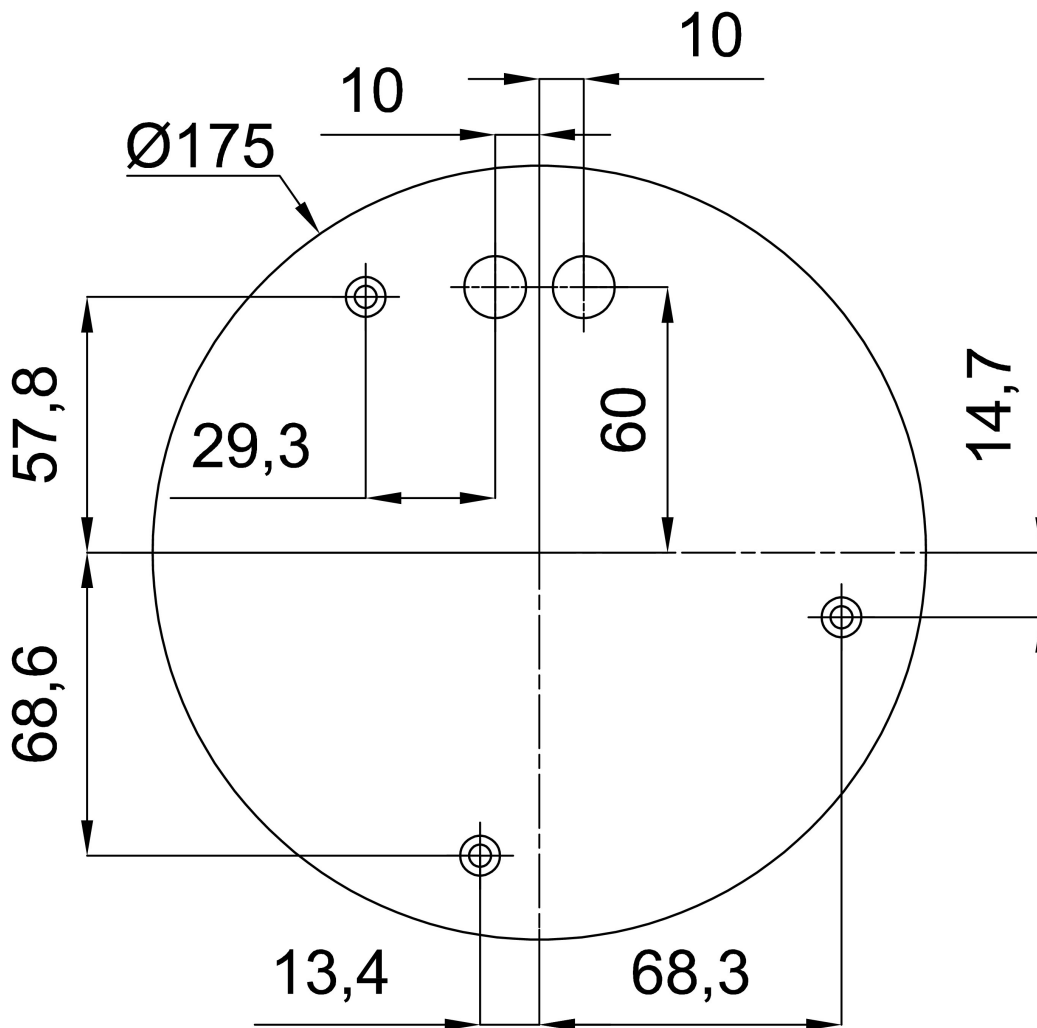

Additional assortment:

Lampshade

Product code	Name	Color	Picture	Drawing
20144	097	white		