



ADRIA S3

ZS11/096/L100 C HF*

WWW.OSMONT.CZ

ADRIA S3

Product code: ADR45387

Type: ZS11/096/L100 C HF*

Short description of the luminaire: Black color | pendant E27 light | microwave HF sensor | TRIPLEX OPAL glass shade with matt surface

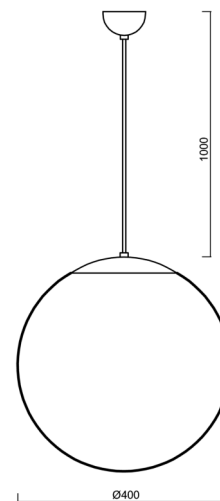

Technical

Types of luminaires	Sensor
Mounting type	Suspended - cable
Base material	steel
Shade material	three-layer glass TRIPLEX OPAL
Base color	black Ral9005
Shade color	white
Holding the shade	steel holder
Mounting location	ceiling
Width	400 mm
Length	400 mm
Height	400 mm
Diameter	Ø 400 mm
Hinge length	1000 mm
mounting holes (diameter)	none
Installation wire (diameter)	none
Impact strength	IK01
Operating temperature	from -20°C to +30°C

Electric

Power consumption	40 W
Ingress Protection	IP40
Socket	E27
Sensor	HF
terminal block	none

Luminous

Blue light hazard	Risk group 0
-------------------	--------------

Eulum data for calculation programs are available at www.osmont.cz.



Logistic

EAN	8591728101701
Weight NTTO	3.8 Kg
Weight BTTO	4.5 Kg
Number of cartons	2 pcs
Package volume	0.072 m ³
Package 1 width	0.405 m
Package 1 length	0.405 m
Package 1 height	0.41 m
Warranty*	60 months

*The warranty for the batteries is valid for 12 months from the date of purchase.

Installation dimensions:

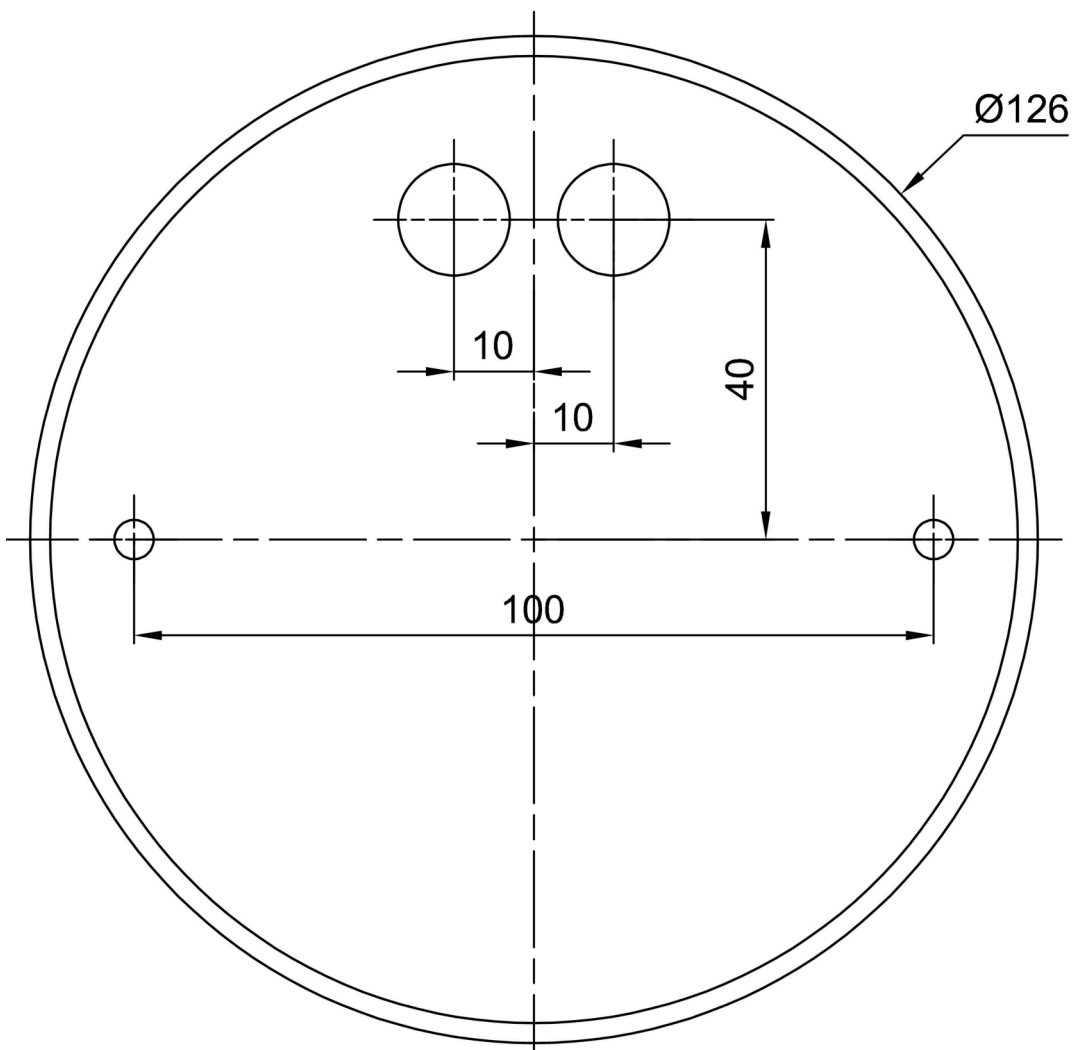

Additional assortment:

Lampshade

Product code	Name	Color	Description	Picture	Drawing
20040	096	white			