



DELIA V2

IN-22KNV83/PC23 HF*

WWW.OSMONT.CZ

DELIA V2

Produktcode: DEL52541

Art: IN-22KNV83/PC23 HF*

Kurzbeschreibung der leuchte: Weiß Farbe | Halbeinbauleuchte E27 EIN/AUS mit HF sensor | Opaler Schirm aus Polycarbonat (PC)

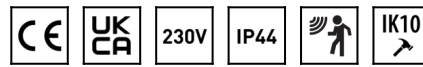

Technisch

Arten von leuchten	Sensor
Befestigungsart	Halbeinbauleuchten
Basismaterial	Stahl
Schattenmaterial	opales Polycarbonat
Grundfarbe	Weiß Ral9003
Schattenfarbe	Weiß
Schatten halten	Faltsystem
Montageort	Wand / Decke
Breite	400 mm
Länge	400 mm
Höhe	64 mm
Durchmesser	ø 400 mm
Montageloch	keiner
Kabeldurchgang	2xØ16mm
Schlagfestigkeit	IK10
Betriebstemperatur	von -20°C bis +30°C

Elektrisch

Spannungstyp	AC
Wechselstrom Spannung	220 - 240 V
Energieverbrauch	2x25 W
Schutz vor Eindringen	IP44
Steckdose	E27
Sensor	HF
Klemme	Schnappklemmenblock

Leuchtdend

Fotobiologische Sicherheit der Leuchte	Risk group 0
--	--------------

Eulum-Daten für Berechnungsprogramme sind unter www.osmont.cz verfügbar.

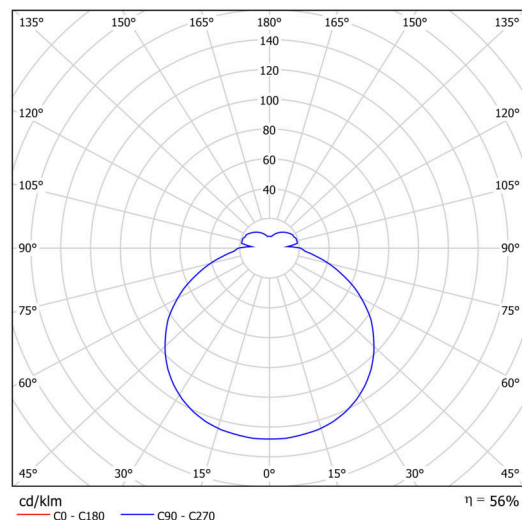
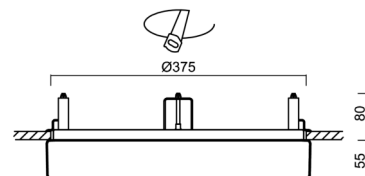
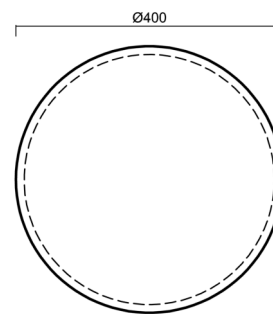

Logistik

EAN	8591728525415
Gewicht NTTO	1.85 Kg
Gewicht BTTO	2.25 Kg
Anzahl kartons	1 Stck
Paketvolumen	0.031 m ³
Paket 1 breite	0.41 m
Paket 1 länge	0.42 m
Paket 1 höhe	0.18 m
Garantie*	60 Monate

*Die Garantie für die Batterien gilt für 12 Monate ab Kaufdatum.

Einbaumaße:



Svítlidlo nesmí být z horní strany zakryto izolací.
Luminaire must not be covered with insulating matting.

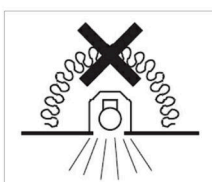

Rozměry dutiny pro vestavné svítidlo [mm]:
Dimensions of cavity for recessed luminaire [mm]:

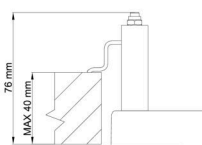
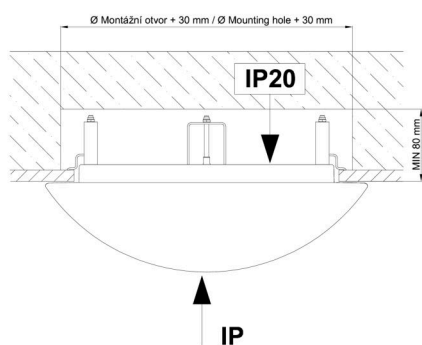

Montáž do pevných materiálů - sádkarton, dřevo.
Mounting into solid materials - plasterboard, wood.

Zusätzliches Sortiment:

Lampenschirm

Produktcode	Name	Farbe	Beschreibung	Bild	Zeichnung
20522	PC23	Weiß	příslušenství	