



DELIA CV2

IN-22KNV83/PM23C*

WWW.OSMONT.CZ

DELIA CV2

Produktcode: DEL52623

Art: IN-22KNV83/PM23C*

Kurzbeschreibung der leuchte: Weiße Halbeinbauleuchte mit Glühbirne ON/OFF und PMMA-Schirm mit einem schwarzen Zierstreifen.

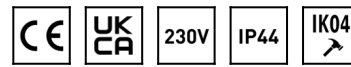

Technisch

Arten von leuchten	Klassisch on/off
Befestigungsart	Halbeinbauleuchten
Basismaterial	Stahl
Schattenmaterial	opales Polymethylmethacrylat
Grundfarbe	Weiß Ral9003
Schattenfarbe	Weiß schwarz
Schatten halten	Faltsystem
Montageort	Wand / Decke
Breite	400 mm
Länge	400 mm
Höhe	64 mm
Durchmesser	ø 400 mm
Montageloch	keiner
Kabeldurchgang	2xØ16mm
Schlagfestigkeit	IK04
Betriebstemperatur	von -20°C bis +30°C

Elektrisch

Spannungstyp	AC
Wechselstrom Spannung	220 - 240 V
Energieverbrauch	2x25 W
Schutz vor Eindringen	IP44
Steckdose	E27
Klemme	Schnappklemmenblock

Leuchtend

Fotobiologische Sicherheit der Leuchte	Risk group 0
--	--------------

Eulum-Daten für Berechnungsprogramme sind unter www.osmont.cz verfügbar.

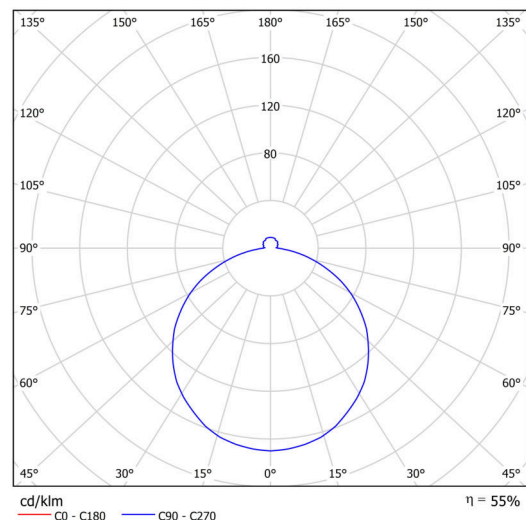
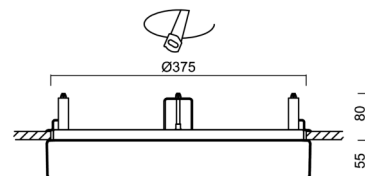
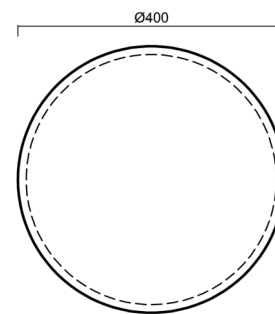

Logistik

EAN	8591728526238
Gewicht NTTO	1.65 Kg
Gewicht BTTO	2.05 Kg
Anzahl kartons	1 Stck
Paketvolumen	0.031 m ³
Paket 1 breite	0.41 m
Paket 1 länge	0.42 m
Paket 1 höhe	0.18 m
Garantie*	60 Monate

*Die Garantie für die Batterien gilt für 12 Monate ab Kaufdatum.

Einbaumaße:

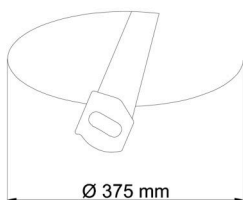

Svítlidlo nesmí být z horní strany zakryto izolací.
Luminaire must not be covered with insulating matting.

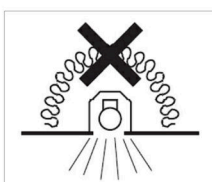

Rozměry dutiny pro vestavné svítidlo [mm]:
Dimensions of cavity for recessed luminaire [mm]:

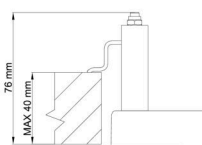
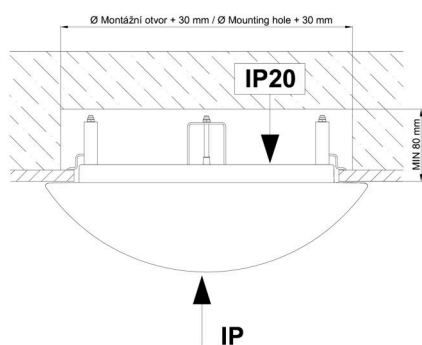

Montáž do pevných materiálů - sádkarton, dřevo.
Mounting into solid materials - plasterboard, wood.

Zusätzliches Sortiment:

Lampenschirm

Produktcode	Name	Farbe	Beschreibung	Bild	Zeichnung
20571	PM23C	Weiß schwarz		