



ZETA 1 PF

LED-1L64E700K2H/PF91 B DALI 4K#

WWW.OSMONT.CZ

ZETA 1 PF

Product code: ZET60525

Type: LED-1L64E700K2H/PF91 B DALI 4K#

Short description of the luminaire: White color | surface-mounted LED light | dimmable DALI | indirect lighting version | PMMA matt shade



Technical

Types of luminaires	Dimmable
Mounting type	surface mounted
Base material	steel
Shade material	opal polymethyl methacrylate
Base color	white Ral9003
Shade color	white
Mounting location	ceiling/wall
Width	400 mm
Length	400 mm
Height	105 mm
Diameter	ø 400 mm
mounting holes (diameter)	3xø5mm
Installation wire (diameter)	2xø16mm
Energy Class	C
Operating temperature	from -20°C to +30°C

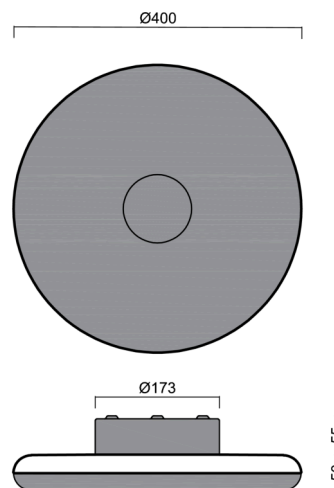

Electric

Power consumption	31 W
Ingress Protection	IP40
Socket	LED modul
terminal block	snap terminal block
Automatic circuit breaker type B10A	31 pcs
Automatic circuit breaker type B16A	50 pcs
Automatic circuit breaker type C10A	52 pcs
Automatic circuit breaker type C16A	85 pcs

Luminous

Lum. flux of luminaire	2900 lm
Lum. flux of light source	5030 lm
Luminaire efficacy	93 lm/W
Temperature	4000 K
Rated life time LED L80/B10	100000 hours
CRI	Ra80
MacAdam	3
Blue light hazard	Risk group 0

Eulum data for calculation programs are available at www.osmont.cz.

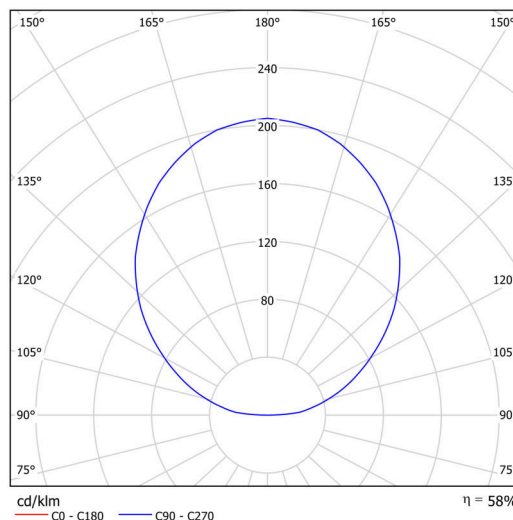

Logistic

EAN	8591728091484
Weight NTTO	2.8 Kg
Weight BTTO	3.1 Kg
Warranty*	60 months

*The warranty for the batteries is valid for 12 months from the date of purchase.

Installation dimensions:

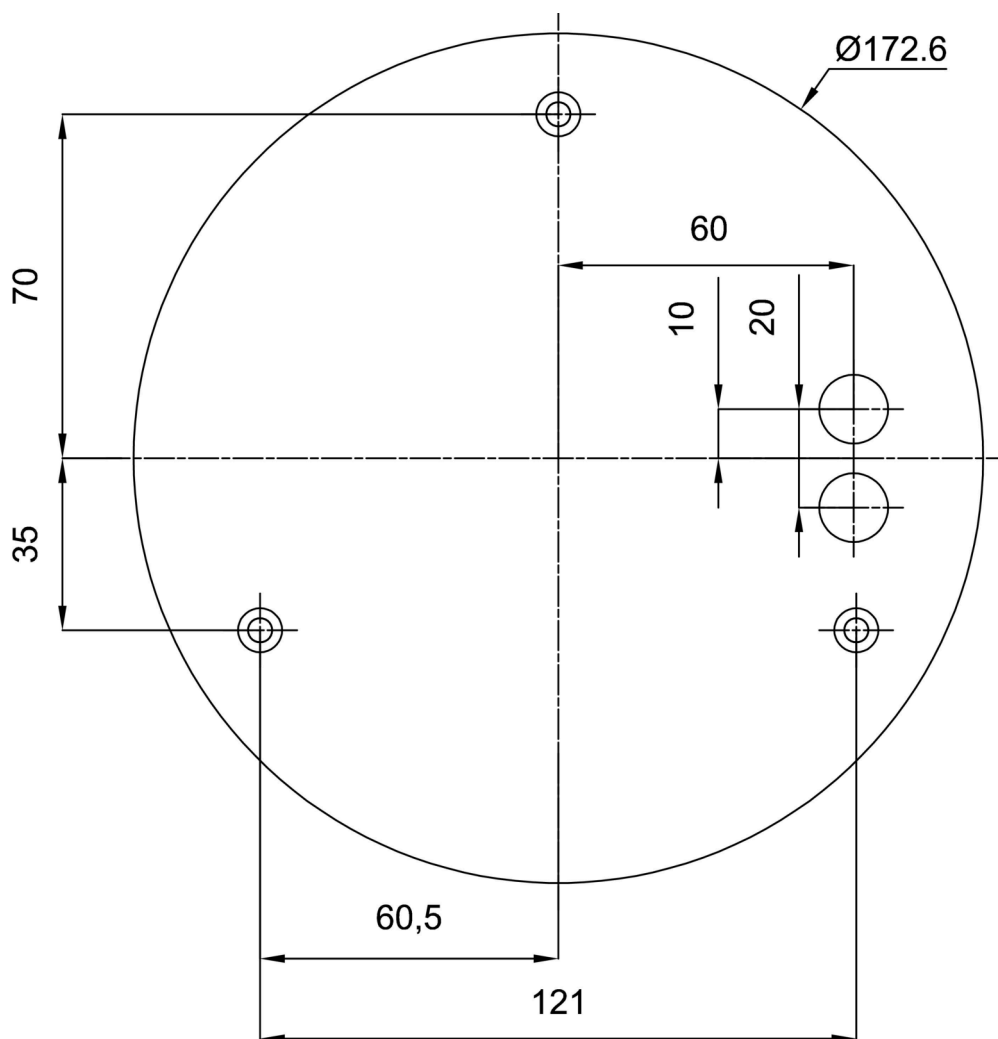

Additional assortment:

Lampshade

Product code	Name	Color	Description	Picture	Drawing
20668	PM91	white		