



## TRITON 2

---

LED-1L15E500/IN-184/NK1W HF C 3K#

[WWW.OSMONT.CZ](http://WWW.OSMONT.CZ)

# TRITON 2

Product code: TRI57285

Type: LED-1L15E500/IN-184/NK1W HF C 3K#

Short description of the luminaire: Black industrial LED light with emergency unit combined with sensor and polycarbonate shade.



## Technical

Types of luminaires	Emergency combined + sensor
Mounting type	industrial
Base material	polycarbonate
Shade material	opal polycarbonate
Base color	black Ral9005
Shade color	white
Holding the shade	bayonet
Mounting location	ceiling/wall
Width	360 mm
Length	360 mm
Height	108 mm
Diameter	ø 360 mm
mounting holes (diameter)	3xø5mm
Installation wire (diameter)	2xø16mm
Energy Class	D
Impact strength	IK10
Operating temperature	from -20°C to +30°C

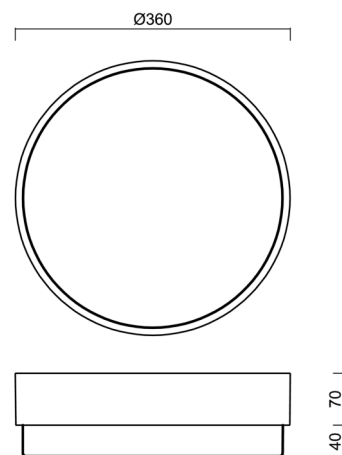

## Electric

Power consumption	19 W
Ingress Protection	IP65
Socket	LED modul
Sensor	HF
Battery type	NiCd
Emergency time	3 hours
terminal block	snap terminal block
Automatic circuit breaker type B10A	26 pcs
Automatic circuit breaker type B16A	40 pcs
Automatic circuit breaker type C10A	30 pcs
Automatic circuit breaker type C16A	48 pcs

## Luminous

Lum. flux of luminaire	2460 lm
Lum. flux of light source	3000 lm
Lum. flux of light source in emergency mode	150 lm
Luminaire efficacy	129 lm/W
Temperature	3000 K
Rated life time LED L80/B10	100000 hours
CRI	Ra80
MacAdam	3

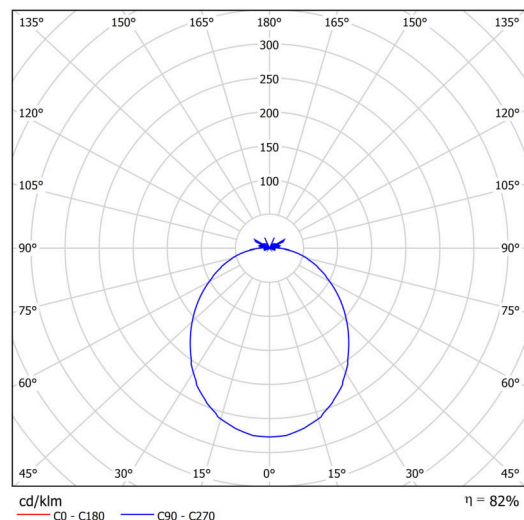

# TECHNICAL SHEET



Blue light hazard	Risk group 0
-------------------	--------------

Eulum data for calculation programs are available at [www.osmont.cz](http://www.osmont.cz).

## Logistic

EAN	8591728134167
Weight NTTO	1.4 Kg
Weight BTTO	1.7 Kg
Number of cartons	1 pcs
Package volume	0.019 m <sup>3</sup>
Package 1 width	0.39 m
Package 1 length	0.37 m
Package 1 height	0.13 m
Warranty*	60 months

\*The warranty for the batteries is valid for 12 months from the date of purchase.

## Installation dimensions:

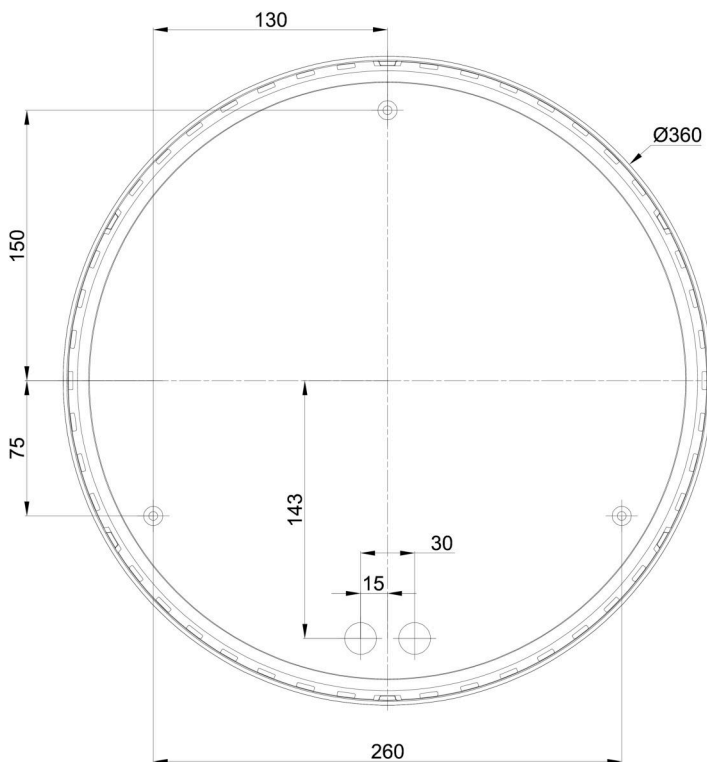

## Additional assortment:

## Lampshade

Product code	Name	Color	Description	Picture	Drawing
20550	184	white		