



TRITON 2

LED-1L15E700/IN-184 B HF CORR 3K#

WWW.OSMONT.CZ

TRITON 2

Product code: TRI57220

Type: LED-1L15E700/IN-184 B HF CORR 3K#

Short description of the luminaire: White industrial LED light with CORRIDOR function and polycarbonate shade.



Technical

Types of luminaires	Corridor
Mounting type	industrial
Base material	polycarbonate
Shade material	opal polycarbonate
Base color	white Ra9003
Shade color	white
Holding the shade	bayonet
Mounting location	ceiling/wall
Width	360 mm
Length	360 mm
Height	108 mm
Diameter	ø 360 mm
mounting holes (diameter)	3xø5mm
Installation wire (diameter)	2xø16mm
Energy Class	D
Impact strength	IK10
Operating temperature	from -20°C to +30°C

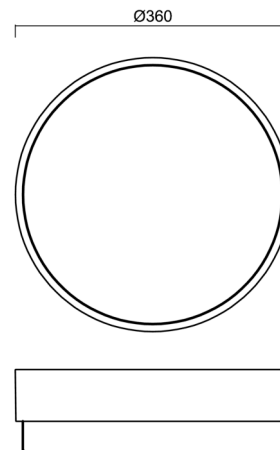

Electric

Power consumption	27 W
Ingress Protection	IP65
Socket	LED modul
Sensor	HF
terminal block	snap terminal block
Automatic circuit breaker type B10A	13 pcs
Automatic circuit breaker type B16A	22 pcs
Automatic circuit breaker type C10A	21 pcs
Automatic circuit breaker type C16A	36 pcs

Luminous

Lum. flux of luminaire	3310 lm
Lum. flux of light source	4040 lm
Luminaire efficacy	122 lm/W
Temperature	3000 K
Rated life time LED L80/B10	100000 hours
CRI	Ra80
MacAdam	3
Blue light hazard	Risk group 0

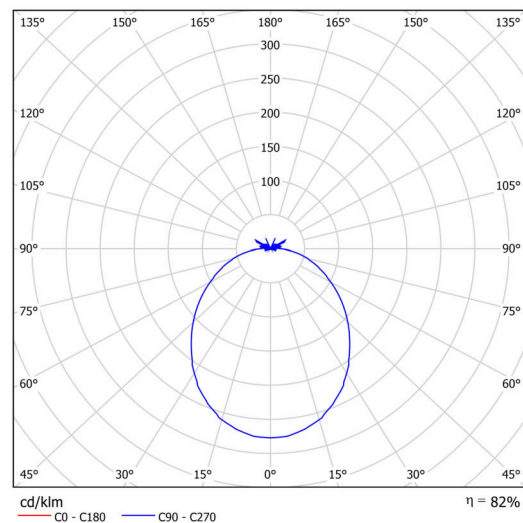

Eulum data for calculation programs are available at www.osmont.cz.

Logistic

EAN	8591728133931
Weight NTTO	1.5 Kg
Weight BTTO	1.8 Kg
Number of cartons	1 pcs
Package volume	0.019 m ³
Package 1 width	0.39 m
Package 1 length	0.37 m
Package 1 height	0.13 m
Warranty*	60 months

*The warranty for the batteries is valid for 12 months from the date of purchase.

Installation dimensions:

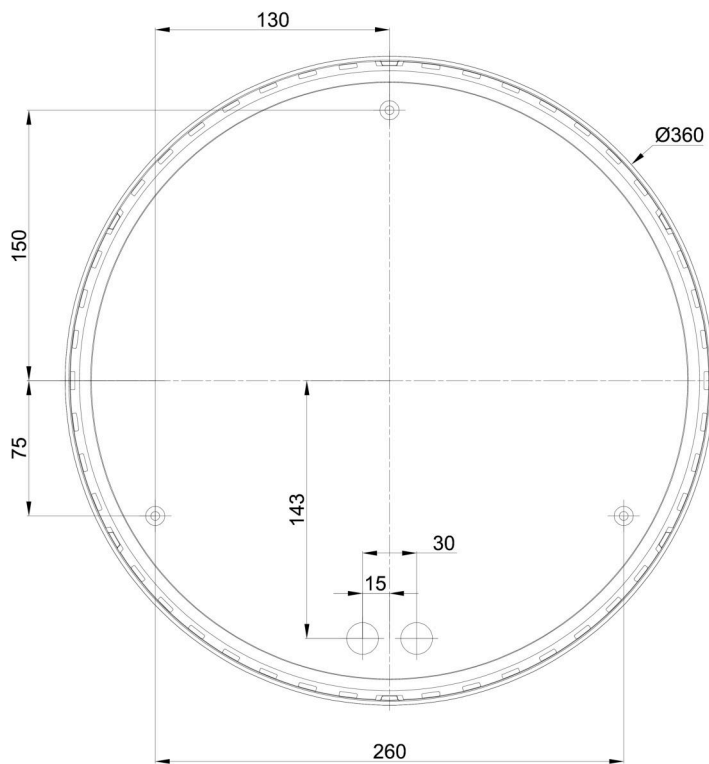

Additional assortment:

Lampshade

Product code	Name	Color	Description	Picture	Drawing
20550	184	white		