



TRITON 1

LED-1L14E700/IN-182 S DALI 4K#

WWW.OSMONT.CZ

TRITON 1

Product code: TRI57713

Type: LED-1L14E700/IN-182 S DALI 4K#

Short description of the luminaire: Silver industrial LED light DALI and polycarbonate shade.



Technical

Types of luminaires	Dimmable
Mounting type	industrial
Base material	polycarbonate
Shade material	opal polycarbonate
Base color	silver Ral9006
Shade color	white
Holding the shade	bayonet
Mounting location	ceiling/wall
Width	280 mm
Length	280 mm
Height	95 mm
Diameter	ø 280 mm
mounting holes (diameter)	3xø5mm
Installation wire (diameter)	2xø16mm
Energy Class	D
Impact strength	IK10
Operating temperature	from -20°C to +30°C

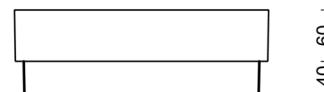
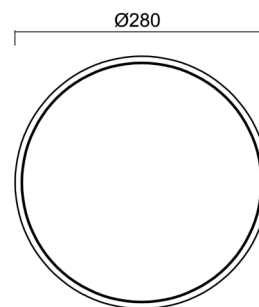

Electric

Power consumption	18 W
Ingress Protection	IP65
Socket	LED modul
terminal block	snap terminal block
Automatic circuit breaker type B10A	31 pcs
Automatic circuit breaker type B16A	50 pcs
Automatic circuit breaker type C10A	52 pcs
Automatic circuit breaker type C16A	85 pcs

Luminous

Lum. flux of luminaire	2300 lm
Lum. flux of light source	2810 lm
Luminaire efficacy	127 lm/W
Temperature	4000 K
Rated life time LED L80/B10	100000 hours
CRI	Ra80
MacAdam	3
Blue light hazard	Risk group 0

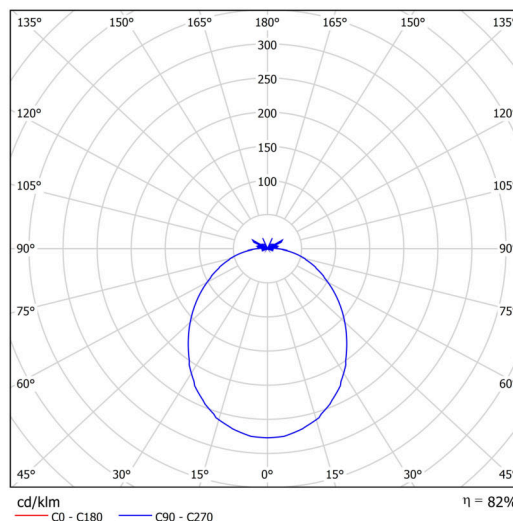

Eulum data for calculation programs are available at www.osmont.cz.

Logistic

EAN	8591728134365
Weight NTTO	1.1 Kg
Weight BTTO	1.3 Kg
Number of cartons	1 pcs
Package volume	0.012 m ³
Package 1 width	0.31 m
Package 1 length	0.29 m
Package 1 height	0.13 m
Warranty*	60 months

*The warranty for the batteries is valid for 12 months from the date of purchase.

Installation dimensions:

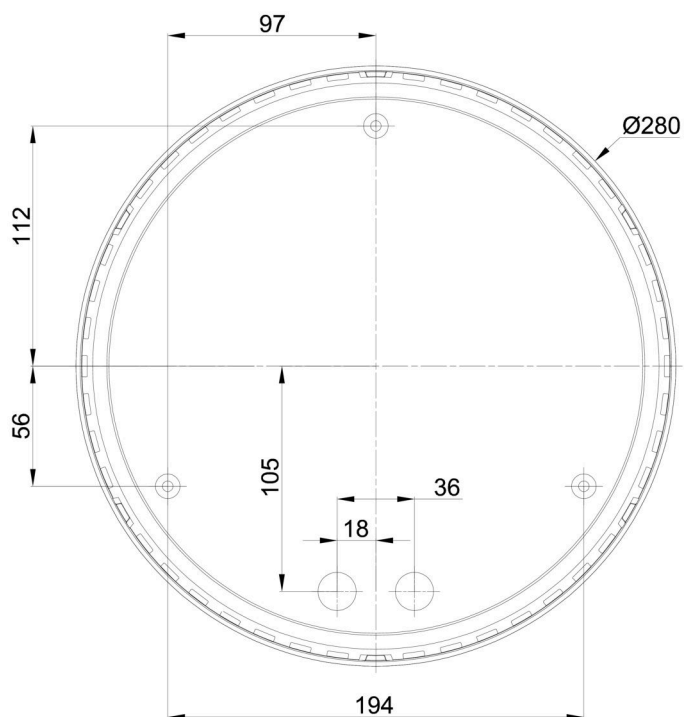

Additional assortment:

Lampshade

Product code	Name	Color	Description	Picture	Drawing
20549	182	white		