



TRITON 1

LED-1L14E500/IN-182 NK3HST B 3K#

WWW.OSMONT.CZ

TRITON 1

Product code: TRI57292

Type: LED-1L14E500/IN-182 NK3HST B 3K#

Short description of the luminaire: White colour | industrial LED light with emergency backup combined (with Self-test) | opal polycarbonate shade (PC)

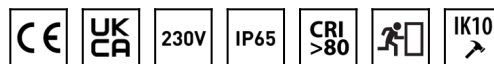

Technical

Types of luminaires	Emergency combined
Mounting type	industrial
Base material	polycarbonate
Shade material	opal polycarbonate
Base color	white Ral9003
Shade color	white
Holding the shade	bayonet
Mounting location	ceiling/wall
Width	280 mm
Length	280 mm
Height	95 mm
mounting holes (diameter)	3xØ5mm
Cable entrance	2xØ16mm
Energy Class	D
Impact strength	IK10
Operating temperature	from 0°C to +30°C

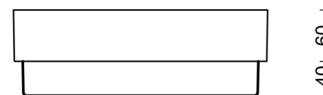
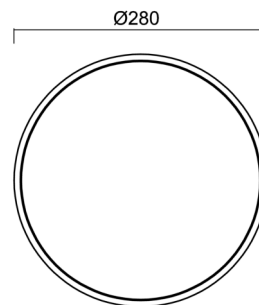

Electric

Power consumption	13 W
Ingress Protection	IP65
Socket	LED modul
Battery type	LiFePO4
Emergency time	3 hours
SELFTEST	yes
terminal block	snap terminal block

Luminous

Lum. flux of luminaire	1640 lm
Lum. flux of light source	2000 lm
Lum. flux of light source in emergency mode	200 lm
Temperature	3000 K
Rated life time LED L80/B10	100000 hours
CRI	Ra80
MacAdam	3
Blue light hazard	Risk group 0

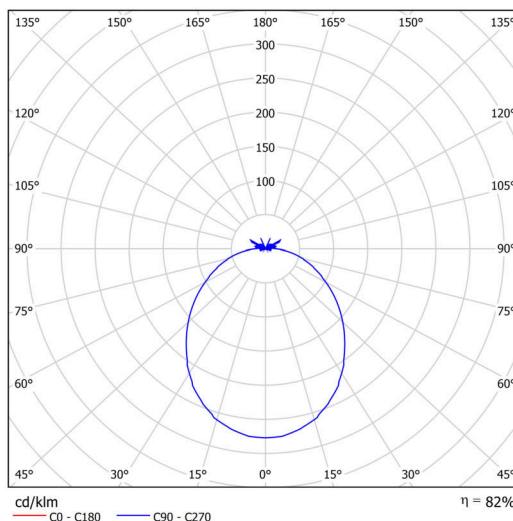

Eulum data for calculation programs are available at www.osmont.cz.

Logistic

EAN	8591728159924
Weight NTT0	1.5 Kg

TECHNICAL SHEET

Weight BTTO	1.7 Kg
Number of cartons	1 pcs
Package volume	0.012 m ³
Package 1 width	0.29 m
Package 1 length	0.31 m
Package 1 height	0.13 m
Warranty*	60 months

*The warranty for the batteries is valid for 12 months from the date of purchase.

Installation dimensions:

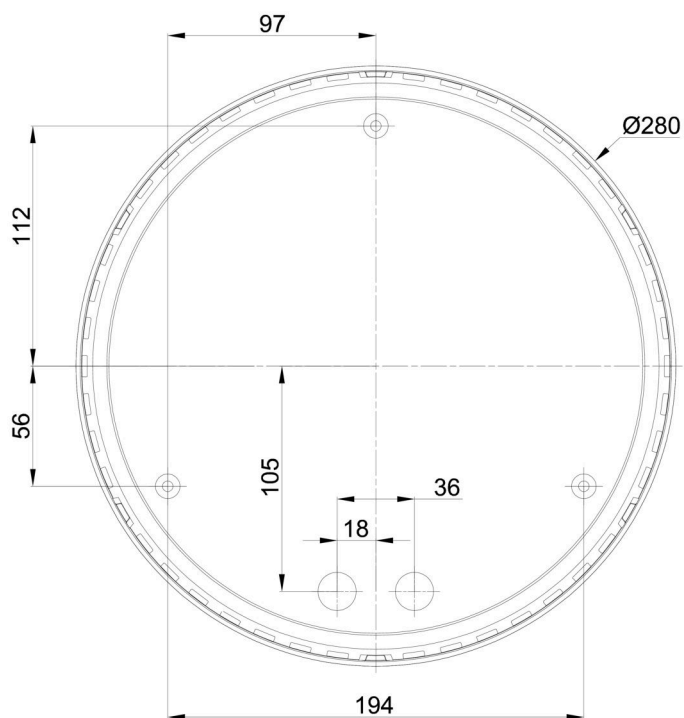

Additional assortment:

Lampshade

Product code	Name	Color	Description	Picture	Drawing
20549	182	white	příslušenství	