



TITAN L3

LED-1L23EMP1050ZLN94/PM09/L100 B 4K##

WWW.OSMONT.CZ

TITAN L3

Product code: TIT66814

Type: LED-1L23EMP1050ZLN94/PM09/L100 B 4K##

Short description of the luminaire: White colour | pendant LED light ON/OFF | multipower driver | PMMA shade | steel wire pendant (with supply cable) 100 cm |

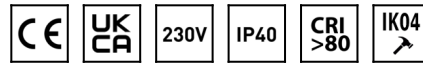

Technical

Types of luminaires	Classic on/off
Mounting type	Suspended - wire
Base material	steel
Shade material	opal polymethyl methacrylate
Base color	white Ral9003
Shade color	white
Holding the shade	folding system
Mounting location	ceiling
Width	500 mm
Length	500 mm
Height	130 mm
Diameter	ø 500 mm
Hinge length	1000 mm
mounting holes (diameter)	2xø5mm
Cable entrance	2xø16mm
Energy Class	D
Impact strength	IK04
Operating temperature	from -20°C to +30°C

Electric

Power consumption	54 W
Ingress Protection	IP40
Socket	LED modul
terminal block	snap terminal block
Automatic circuit breaker type B10A	24 pcs
Automatic circuit breaker type B16A	40 pcs
Automatic circuit breaker type C10A	24 pcs
Automatic circuit breaker type C16A	40 pcs

Luminous

Lum. flux of luminaire	5820 lm
Lum. flux of light source	8430 lm
Luminaire efficacy	107 lm/W
Temperature	4000 K
Rated life time LED L80/B10	100000 hours
CRI	Ra80
MacAdam	3
Blue light hazard	Risk group 0

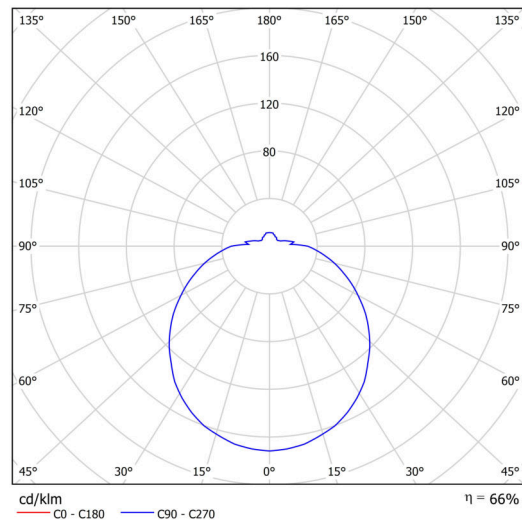
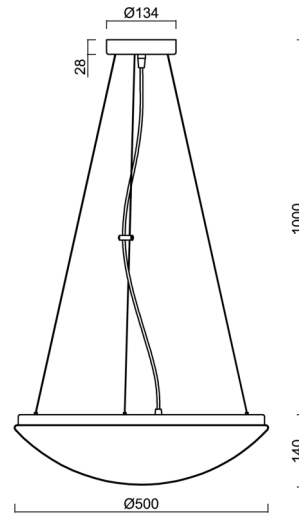

Eulum data for calculation programs are available at www.osmont.cz.

TECHNICAL SHEET



Multipower

Possibility of output adjustment by the user (DIP switch on the current source).

I [mA]	1050	900	850	700	
[%]	100	86	81	67	

Logistic

EAN	8591728161286
Warranty*	60 months

*The warranty for the batteries is valid for 12 months from the date of purchase.

Installation dimensions:

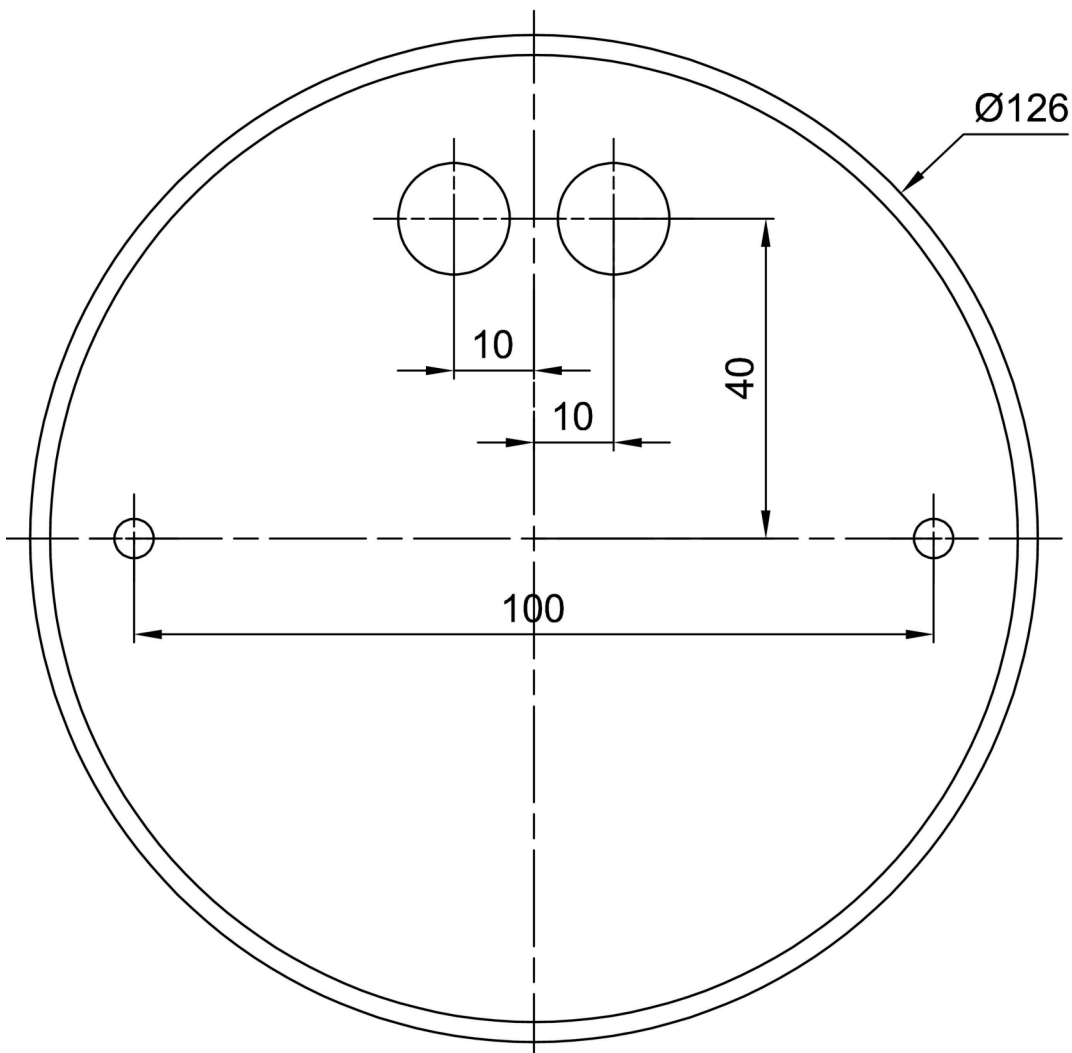

Additional assortment:

Lampshade

Product code	Name	Color	Description	Picture	Drawing
20509	PM09	white	příslušenství	