



TITAN D1

LED-1L14EMP700KN62/PC06/DP C 4K#

WWW.OSMONT.CZ

TITAN D1

Product code: TIT56770

Type: LED-1L14EMP700KN62/PC06/DP C 4K#

Short description of the luminaire: Black colour | ceiling or wall LED light ON/OFF | multipower driver | opal polycarbonate shade (PC) with decorative collar



Technical data

Types of luminaires	Classic on/off
Mounting type	surface mounted
Base material	steel
Shade material	opal polycarbonate
Base color	black Ral9005
Shade color	white
Holding the shade	folding system
Mounting location	ceiling/wall
Width	338 mm
Length	85 mm
Height	338 mm
Diameter	ø 338 mm
mounting holes (diameter)	2xø5mm
Cable entrance	2xø16mm
Energy Class	D
Impact strength	IK10
Operating temperature	from -20°C to +30°C

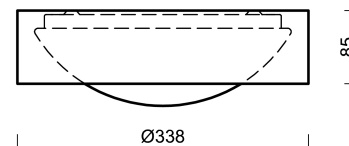
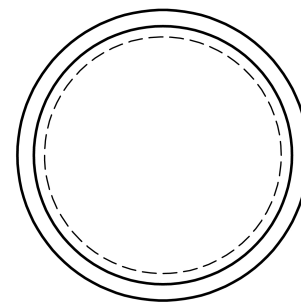

Electrical data

Power consumption	18 W
Ingress Protection	IP54
Socket	LED modul
terminal block	snap terminal block

Luminous data

Lum. flux of luminaire	1550 lm
Lum. flux of light source	2810 lm
Chromaticity temperature	4000 K
Rated life time LED L80/B10	100000 hours
CRI	Ra80
MacAdam	3
Blue light hazard	Risk group 0

Eulum data for calculation programs are available at www.osmont.cz.

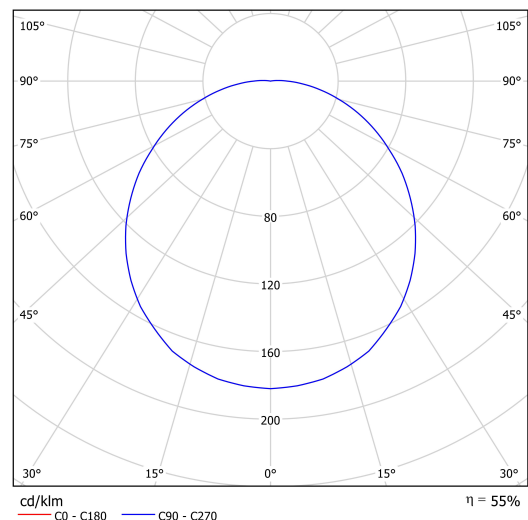

Logistical data

EAN	8591728233099
Number of cartons	1 pcs
Warranty*	60 months

*The warranty for the batteries is valid for 36 months from the date of purchase.

Installation dimensions:

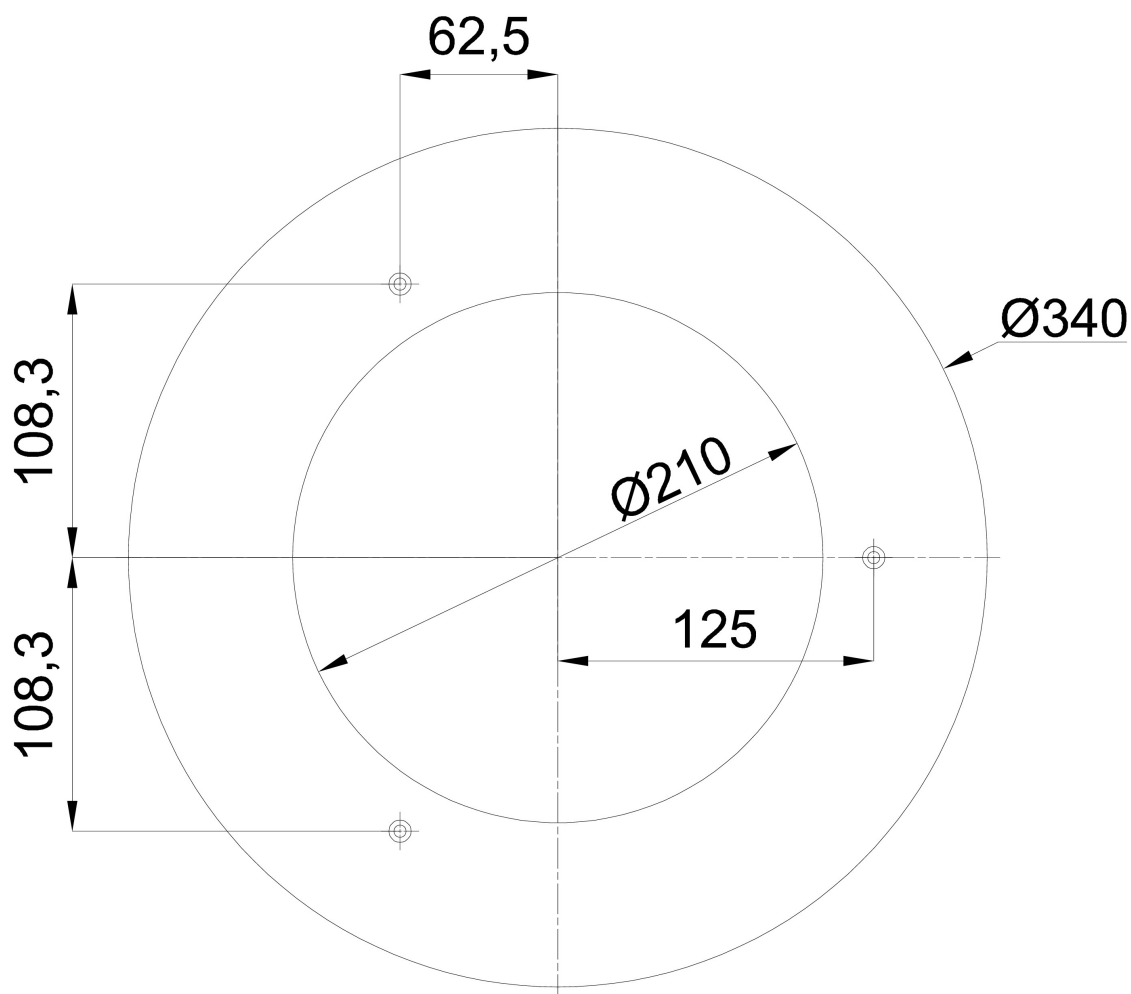

Additional assortment:

Decorative collar

Product code	Name	Color	Picture	Drawing
33543	KN6/DP C	black Ral9005		

Lampshade

Product code	Name	Color	Picture	Drawing
20504	PC06	white	