



TITAN 3

LED-1L23EMP700KN94/PC09 NK3HST 4K##

WWW.OSMONT.CZ

TITAN 3

Product code: TIT66864

Type: LED-1L23EMP700KN94/PC09 NK3HST 4K##

Short description of the luminaire: White colour | ceiling or wall LED light with emergency backup combined (with Self-test) | multipower driver | opal polycarbonate shade (PC)



Technical

Types of luminaires	Emergency combined
Mounting type	surface mounted
Base material	steel
Shade material	opal polycarbonate
Base color	white Ral9003
Shade color	white
Holding the shade	folding system
Mounting location	ceiling/wall
Width	500 mm
Length	500 mm
Height	130 mm
mounting holes (diameter)	3xØ5mm
Cable entrance	2xØ16mm
Energy Class	D
Impact strength	IK10
Operating temperature	from 0°C to +30°C

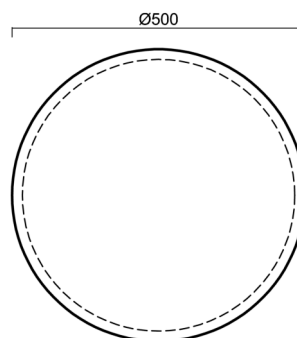

Electric

Power consumption	35 W
Ingress Protection	IP54
Socket	LED modul
Battery type	LiFePO4
Emergency time	3 hours
SELFTEST	yes
terminal block	snap terminal block

Luminous

Lum. flux of luminaire	3860 lm
Lum. flux of light source	5850 lm
Lum. flux of light source in emergency mode	200 lm
Temperature	4000 K
Rated life time LED L80/B10	100000 hours
CRI	Ra80
MacAdam	3
Blue light hazard	Risk group 0

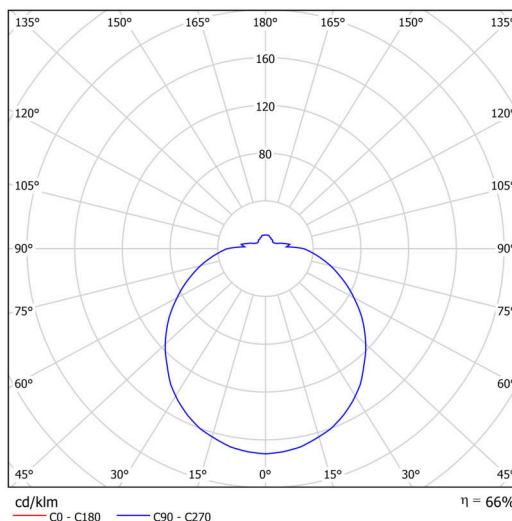

Eulum data for calculation programs are available at www.osmont.cz.

Logistic

EAN	8591728159801
Weight NTT0	2.8 Kg

TECHNICAL SHEET

Weight BTTO	3.3 Kg
Number of cartons	1 pcs
Package volume	0.036 m ³
Package 1 width	0.495 m
Package 1 length	0.515 m
Package 1 height	0.14 m
Warranty*	60 months

*The warranty for the batteries is valid for 12 months from the date of purchase.

Installation dimensions:

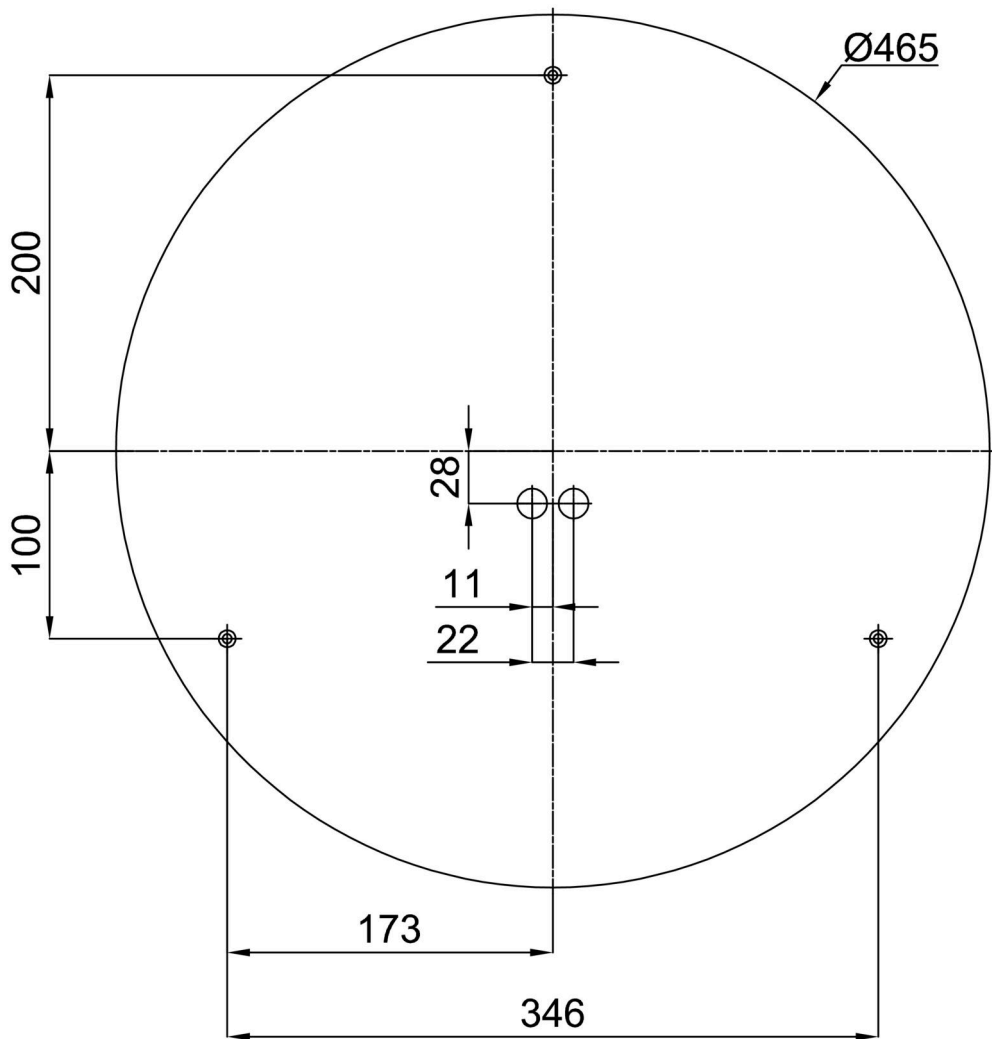

Additional assortment:

Base for surface mounting

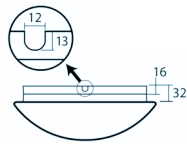
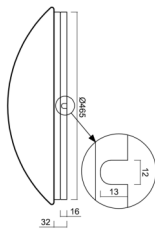
Product code	Name	Color	Description	Picture	Drawing
33503	KN9,K9,B17 /BP	white Ra19003	příslušenství		

Lampshade

Product code	Name	Color	Description	Picture	Drawing
20506	PC09	white	příslušenství	