



TITAN 3

LED-1L23EMP1050KN94/PM09 NK3HST 3K##

WWW.OSMONT.CZ

TITAN 3

Product code: TIT66375

Type: LED-1L23EMP1050KN94/PM09 NK3HST 3K##

Short description of the luminaire: White colour | ceiling or wall LED light with emergency backup combined (with Self-test) | multipower driver | opal polycarbonate shade (PC)|



Technical

Types of luminaires	Emergency combined
Mounting type	surface mounted
Base material	steel
Shade material	opal polymethyl methacrylate
Base color	white Ral9003
Shade color	white
Holding the shade	folding system
Mounting location	ceiling/wall
Width	500 mm
Length	500 mm
Height	130 mm
mounting holes (diameter)	3xØ5mm
Cable entrance	2xØ16mm
Energy Class	D
Impact strength	IK04
Operating temperature	from 0°C to +30°C

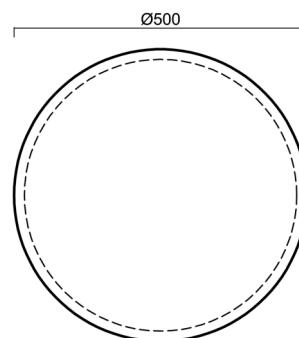

Electric

Power consumption	54 W
Ingress Protection	IP54
Socket	LED modul
Battery type	LiFePO4
Emergency time	3 hours
SELFTEST	yes
terminal block	snap terminal block

Luminous

Lum. flux of luminaire	5580 lm
Lum. flux of light source	8080 lm
Lum. flux of light source in emergency mode	200 lm
Temperature	3000 K
Rated life time LED L80/B10	100000 hours
CRI	Ra80
MacAdam	3
Blue light hazard	Risk group 0

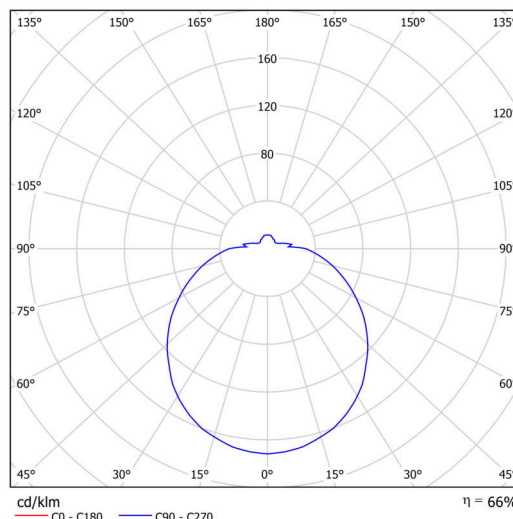

Eulum data for calculation programs are available at www.osmont.cz.

Logistic

EAN	8591728159719
Weight NTTO	2.8 Kg

TECHNICAL SHEET

Weight BTTO	3.3 Kg
Number of cartons	1 pcs
Package volume	0.036 m ³
Package 1 width	0.495 m
Package 1 length	0.515 m
Package 1 height	0.14 m
Warranty*	60 months

*The warranty for the batteries is valid for 12 months from the date of purchase.

Installation dimensions:

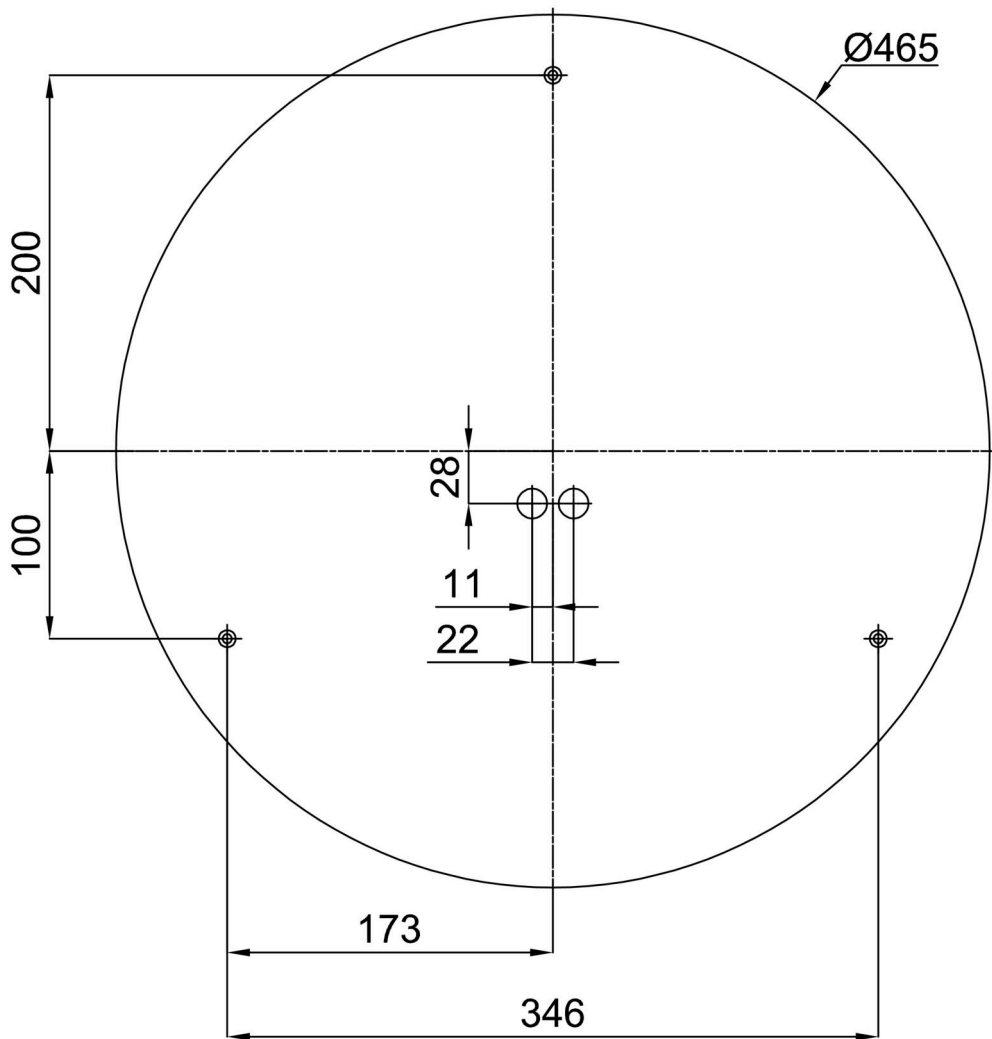

Additional assortment:

Base for surface mounting

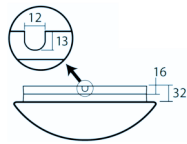
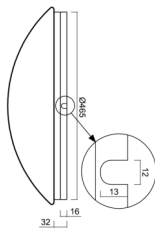
Product code	Name	Color	Description	Picture	Drawing
33503	KN9,K9,B17 /BP	white Ra19003	příslušenství		

Lampshade

Product code	Name	Color	Description	Picture	Drawing
20509	PM09	white	příslušenství	