



# TITAN 1

---

LED-1L14E700KN62/PM06 HF CORR 4K#

[WWW.OSMONT.CZ](http://WWW.OSMONT.CZ)

# TITAN 1

Product code: TIT56502

Type: LED-1L14E700KN62/PM06 HF CORR 4K#

Short description of the luminaire: White color | surface-mounted LED light | CORRIDOR function (HF+DALI) | PMMA shade



## Technical

Types of luminaires	Corridor
Mounting type	surface mounted
Base material	steel
Shade material	opal polymethyl methacrylate
Base color	white Ra9003
Shade color	white
Holding the shade	folding system
Mounting location	ceiling/wall
Width	300 mm
Length	300 mm
Height	105 mm
Diameter	ø 300 mm
mounting holes (diameter)	3xø5mm
Installation wire (diameter)	2xø16mm
Energy Class	D
Impact strength	IK04

## Electric

Power consumption	18 W
Ingress Protection	IP54
Socket	LED modul
Sensor	HF
terminal block	snap terminal block
Automatic circuit breaker type B10A	21 pcs
Automatic circuit breaker type B16A	35 pcs
Automatic circuit breaker type C10A	35 pcs
Automatic circuit breaker type C16A	58 pcs

## Luminous

Lum. flux of luminaire	2000 lm
Lum. flux of light source	2810 lm
Luminaire efficacy	111 lm/W
Temperature	4000 K
Rated life time LED L80/B10	100000 hours
CRI	Ra80
MacAdam	3
Blue light hazard	Risk group 0

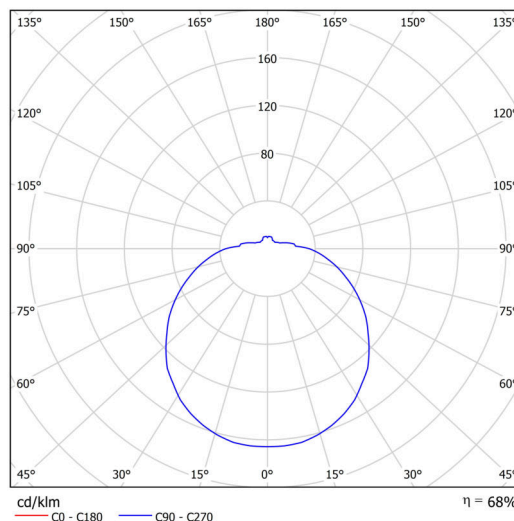
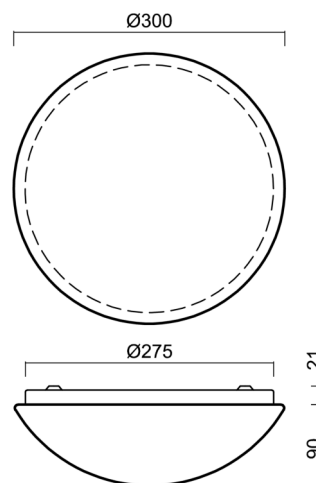

Eulum data for calculation programs are available at [www.osmont.cz](http://www.osmont.cz).

Logistic

EAN	8591728090210
Weight NTTO	0.9 Kg
Weight BTTO	1.1 Kg
Number of cartons	1 pcs
Package 1 width	0.3 m
Package 1 length	0.285 m
Package 1 height	0.13 m
Warranty*	60 months

\*The warranty for the batteries is valid for 12 months from the date of purchase.

Installation dimensions:

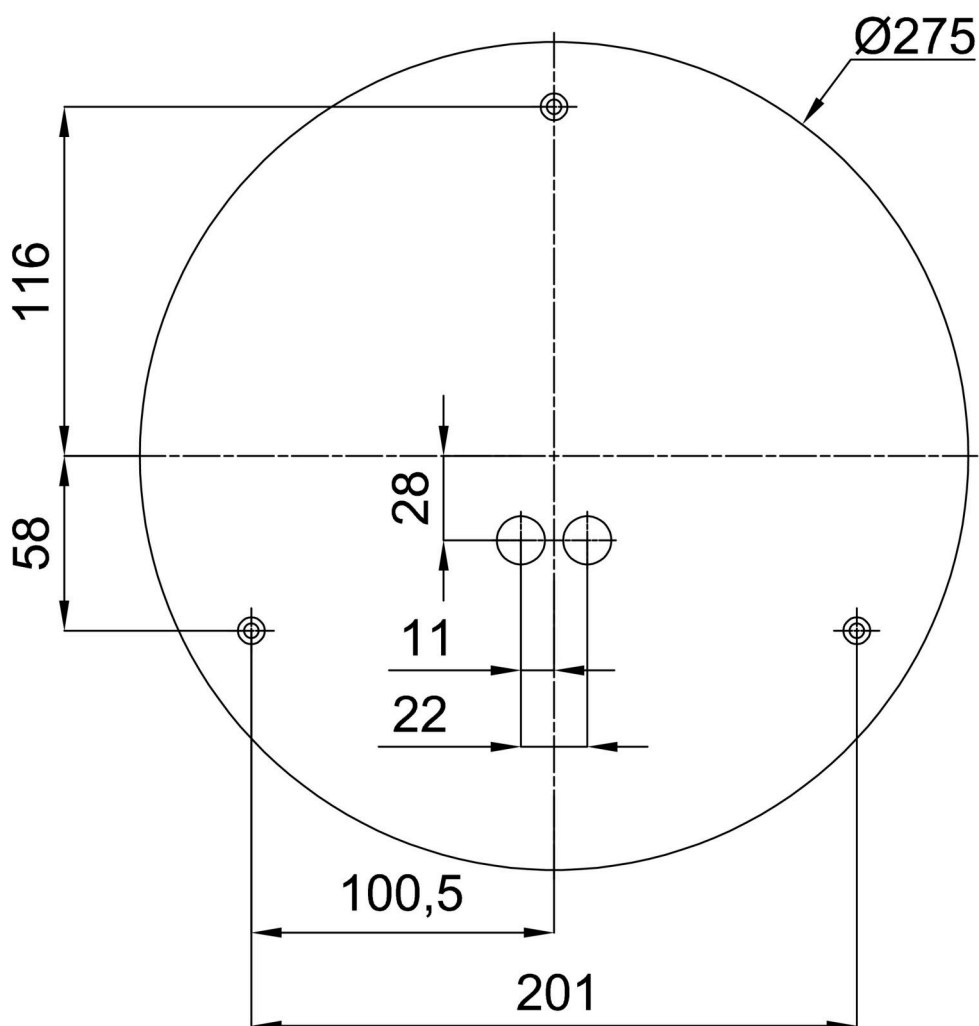

Additional assortment:

Base for surface mounting

Product code	Name	Color	Description	Picture	Drawing
33501	KN6,K6/BP	white Ra19003			

Lampshade

Product code	Name	Color	Description	Picture	Drawing
20507	PM06	white		