



TANIA P1 HP

LED-5L08E850Z11/296/a5 MS DALI 4K#

WWW.OSMONT.CZ

TANIA P1 HP

Product code: TAN62769

Type: LED-5L08E850Z11/296/a5 MS DALI 4K#

Short description of the luminaire: Brass polished | pendant high-power LED light DALI | TRIPLEX OPAL hand blown glass shade | rod pendant 100 cm |

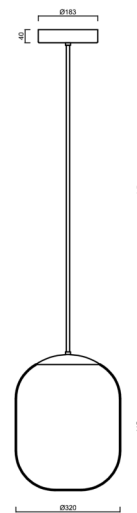
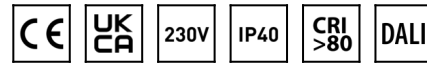

Technical

Types of luminaires	Dimmable
Mounting type	Suspended - rod
Base material	brass
Shade material	three-layer glass TRIPLEX OPAL
Base color	polished brass
Shade color	white
Holding the shade	steel holder
Mounting location	ceiling
Width	320 mm
Length	320 mm
Height	415 mm
Diameter	Ø 320 mm
Hinge length	1000 mm
mounting holes (diameter)	3xØ5mm
Cable entrance	2xØ16mm
Energy Class	D
Impact strength	IK01
Operating temperature	from -20°C to +30°C

Electric

Power consumption	52 W
Ingress Protection	IP40
Socket	LED modul
terminal block	snap terminal block
Automatic circuit breaker type B10A	15 pcs
Automatic circuit breaker type B16A	25 pcs
Automatic circuit breaker type C10A	26 pcs
Automatic circuit breaker type C16A	42 pcs

Luminous

Lum. flux of luminaire	7610 lm
Lum. flux of light source	8650 lm
Luminaire efficacy	146 lm/W
Temperature	4000 K
Rated life time LED L80/B10	100000 hours
CRI	Ra80
MacAdam	3
Blue light hazard	Risk group 0

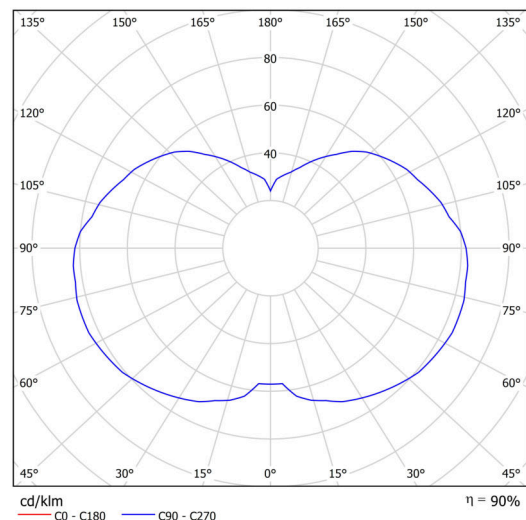

Eulum data for calculation programs are available at

Logistic

EAN	8591728123222
Weight NTTO	5.9 Kg
Weight BTTO	7.2 Kg
Number of cartons	2 pcs
Package volume	0.145 m ³
Package 1 width	0.425 m
Package 1 length	0.425 m
Package 1 height	0.42 m
Warranty*	60 months

*The warranty for the batteries is valid for 12 months from the date of purchase.

Installation dimensions:

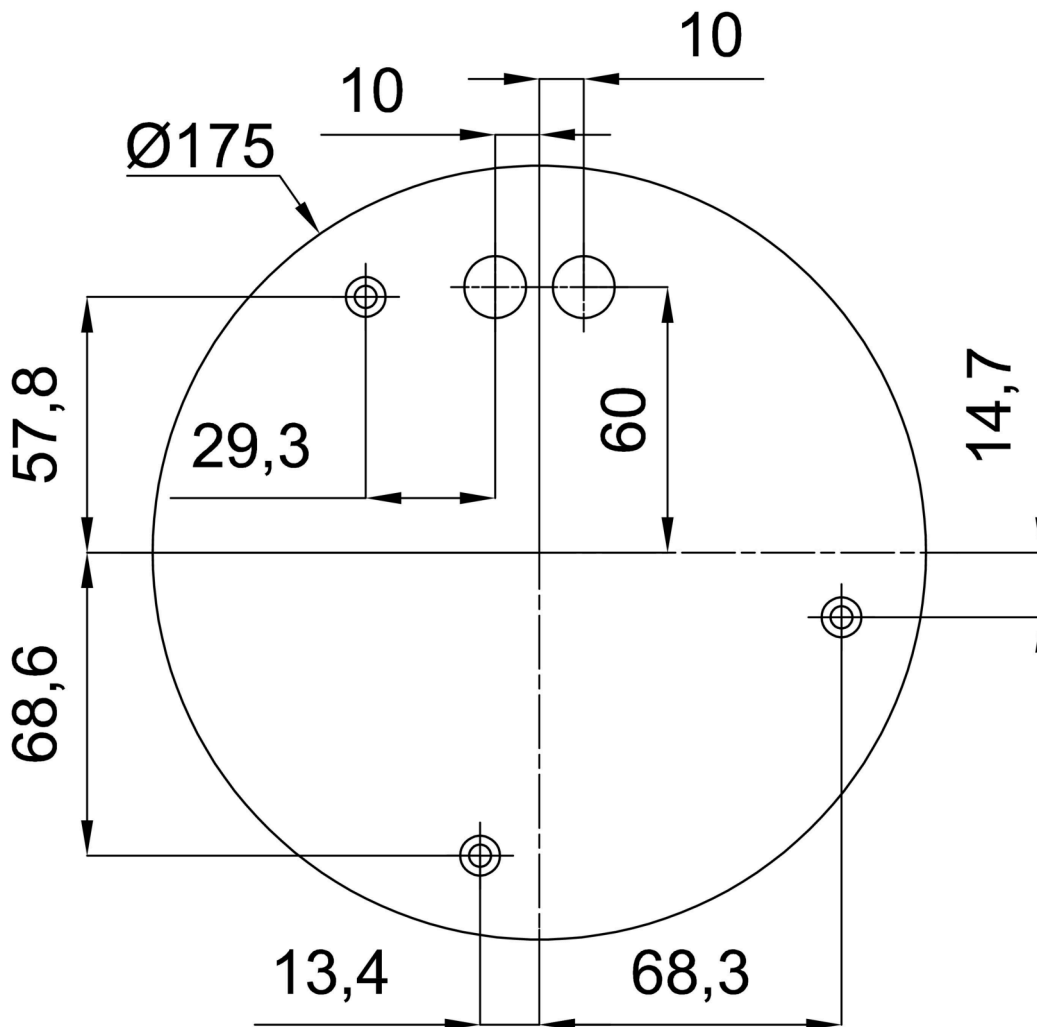

Additional assortment:

Lampshade

Product code	Name	Color	Description	Picture	Drawing
20128	296	white	příslušenství	