



SYLVIA 1 X14

LED-2L25EMP700U12/129/X14 4K##

WWW.OSMONT.CZ

SYLVIA 1 X14

Product code: SYL51922

Type: LED-2L25EMP700U12/129/X14 4K##

Short description of the luminaire: Stainless polished surface-mounted LED light ON/OFF with decorative collar with TRIPLEX OPAL glass shade.

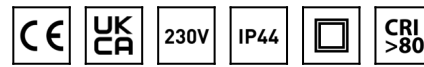

Technical

Types of luminaires	Classic on/off
Mounting type	surface mounted
Base material	steel
Shade material	three-layer glass TRIPLEX OPAL
Base color	polished stainless steel
Shade color	white
Holding the shade	folding system
Mounting location	ceiling/wall
Width	620 mm
Length	110 mm
Height	75 mm
mounting holes (diameter)	2xØ5mm
Installation wire (diameter)	2xØ16mm
Energy Class	D
Impact strength	IK01
Operating temperature	from -20°C to +30°C

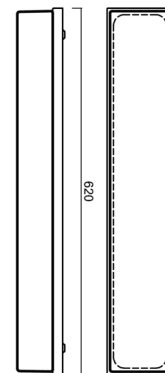

Electric

Power consumption	18 W
Coverage class	2
Ingress Protection	IP44
Socket	LED modul
terminal block	snap terminal block
Automatic circuit breaker type B10A	31 pcs
Automatic circuit breaker type B16A	50 pcs
Automatic circuit breaker type C10A	52 pcs
Automatic circuit breaker type C16A	85 pcs

Luminous

Lum. flux of luminaire	1830 lm
Lum. flux of light source	2810 lm
Luminaire efficacy	101 lm/W
Temperature	4000 K
Rated life time LED L80/B10	100000 hours
CRI	Ra80
MacAdam	3
Blue light hazard	Risk group 0

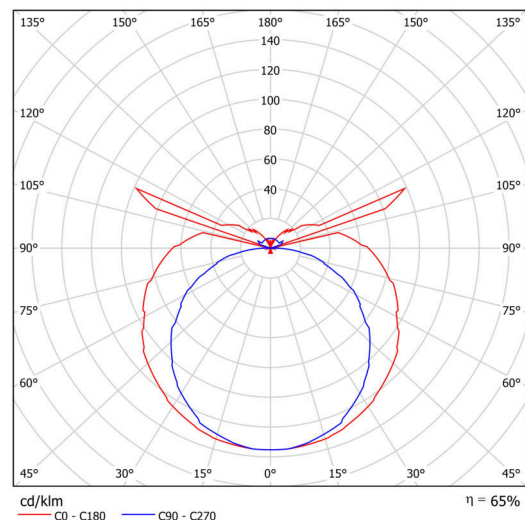

Eulum data for calculation programs are available at www.osmont.cz.

Multipower

Possibility of output adjustment by the user (DIP switch on the current source).

I [mA]	700	650	600	550	500	450	400	350
[%]	100	93	86	79	71	64	57	50

Logistic

EAN	8591728137557
Weight NTTO	2.4 Kg
Weight BTTO	2.6 Kg
Number of cartons	1 pcs
Package volume	0.007 m ³
Package 1 width	0.625 m
Package 1 length	0.125 m
Package 1 height	0.09 m
Warranty*	60 months

**The warranty for the batteries is valid for 12 months from the date of purchase.*

Installation dimensions:

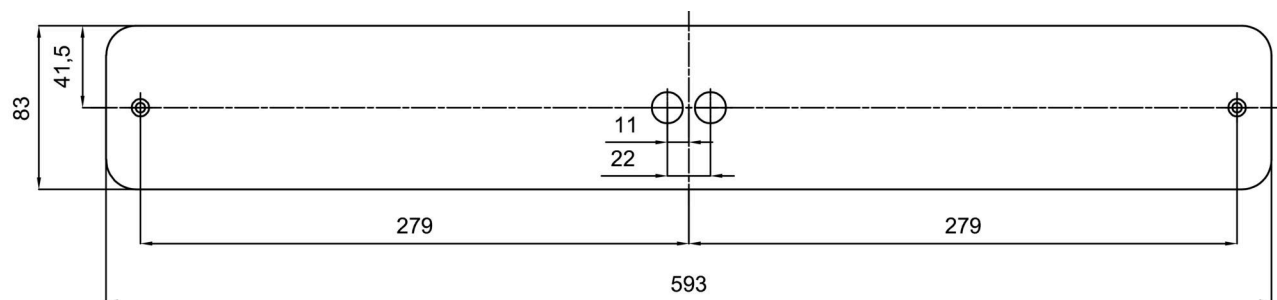

Additional assortment:

Lampshade

Product code	Name	Color	Description	Picture	Drawing
20074	129	white		