



## SUBRA S3

---

LED-18L71E1050ZS/PM83/L100 C DALI 3K##

[WWW.OSMONT.CZ](http://WWW.OSMONT.CZ)

# SUBRA S3

Product code: SUB60011

Type: LED-18L71E1050ZS/PM83/L100 C DALI 3K##

Short description of the luminaire: Black color | pendant LED light | dimmable DALI | PMMA shade



## Technical

Types of luminaires	Dimmable
Mounting type	Suspended - cable
Base material	steel
Shade material	opal polymethyl methacrylate
Base color	black Ral9005
Shade color	white
Holding the shade	screws
Mounting location	ceiling
Width	50 mm
Length	50 mm
Height	1490 mm
Diameter	ø 50 mm
Hinge length	1000 mm
mounting holes (diameter)	2xø5mm
Installation wire (diameter)	2xø16mm
Energy Class	C
Operating temperature	from -20°C to +30°C



## Electric

Power consumption	37 W
Ingress Protection	IP20
Socket	LED modul
terminal block	snap terminal block
Automatic circuit breaker type B10A	31 pcs
Automatic circuit breaker type B16A	50 pcs
Automatic circuit breaker type C10A	52 pcs
Automatic circuit breaker type C16A	85 pcs

## Luminous

Lum. flux of luminaire	4940 lm
Lum. flux of light source	6330 lm
Luminaire efficacy	133 lm/W
Temperature	3000 K
Rated life time LED L80/B10	100000 hours
CRI	Ra80
MacAdam	3
Blue light hazard	Risk group 0

Eulum data for calculation programs are available at [www.osmont.cz](http://www.osmont.cz).

Logistic

EAN	8591728089740
Weight NTTO	2.28 Kg
Weight BTTO	2.72 Kg
Package 1 width	0.135 m
Package 1 length	0.14 m
Package 1 height	1.74 m
Warranty*	60 months

\*The warranty for the batteries is valid for 12 months from the date of purchase.

Installation dimensions:

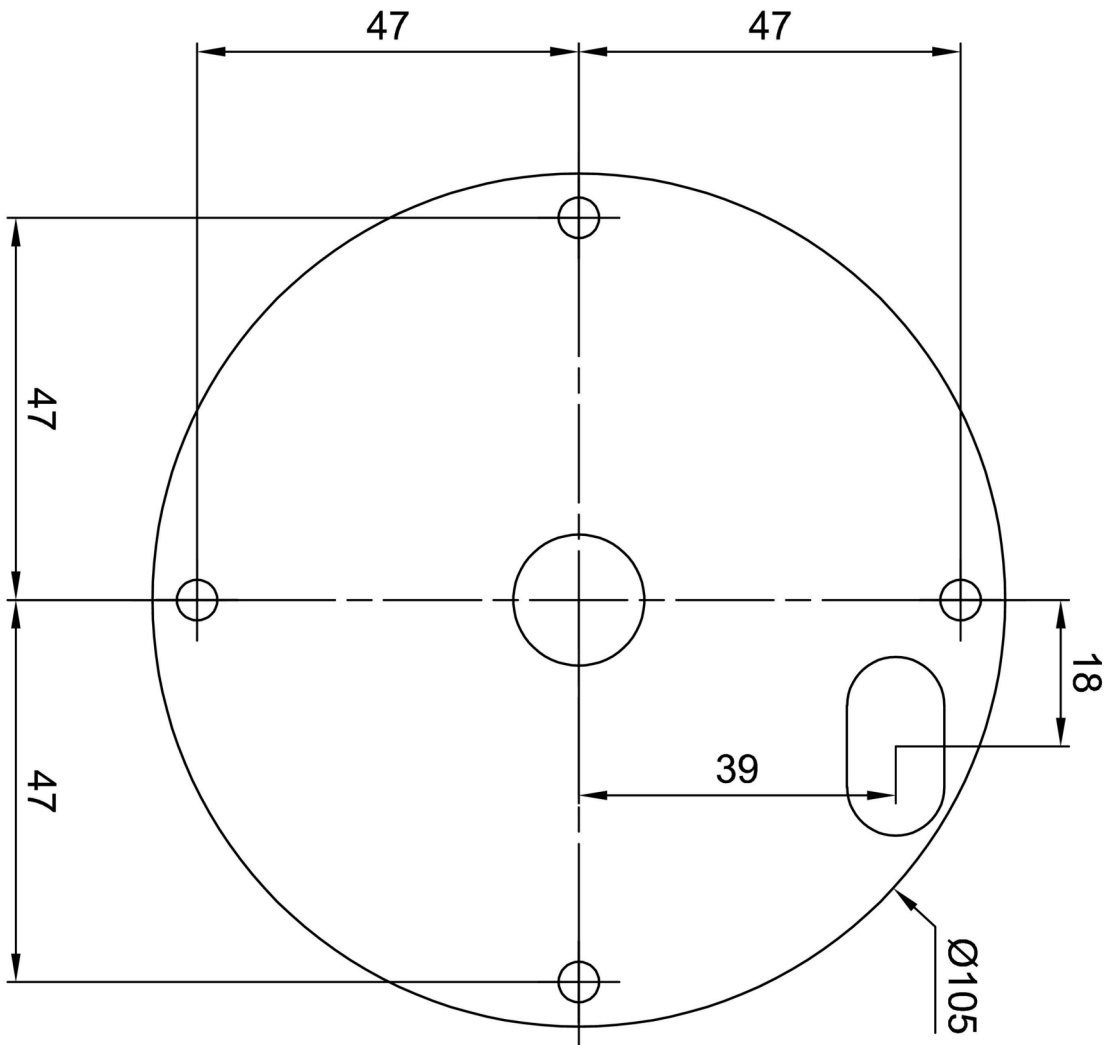

## Additional assortment:

## Lampshade

Product code	Name	Color	Description	Picture	Drawing
20662	PM83	white		