

## SATURN LE2

---

LED-1L62E700ZLEX86/482/L100 S 4K#

[WWW.OSMONT.CZ](http://WWW.OSMONT.CZ)

# SATURN LE2

Product code: SAT67929

Type: LED-1L62E700ZLEX86/482/L100 S 4K#

Short description of the luminaire: Silver pendant LED light ON/OFF with TRIPLEX OPAL glass shade.



## Technical

Types of luminaires	Classic on/off
Mounting type	Suspended - SELV wire (cableless)
Base material	steel
Shade material	three-layer glass TRIPLEX OPAL
Base color	silver Ral9006
Shade color	white
Holding the shade	folding system
Mounting location	ceiling
Width	490 mm
Length	490 mm
Height	130 mm
Diameter	ø 490 mm
Hinge length	1000 mm
mounting holes (diameter)	3xø5mm
Installation wire (diameter)	2xø16mm
Energy Class	D
Impact strength	IK01
Operating temperature	from -20°C to +30°C

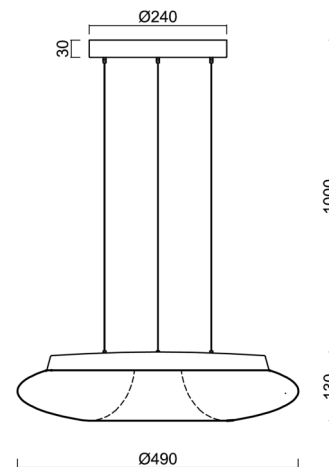
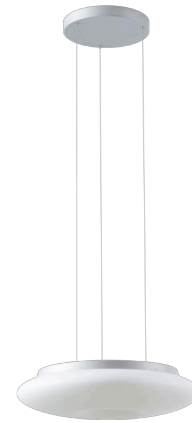

## Electric

Power consumption	31 W
Ingress Protection	IP20
Socket	LED modul
terminal block	snap terminal block
Automatic circuit breaker type B10A	31 pcs
Automatic circuit breaker type B16A	50 pcs
Automatic circuit breaker type C10A	52 pcs
Automatic circuit breaker type C16A	85 pcs

## Luminous

Lum. flux of luminaire	3400 lm
Lum. flux of light source	5000 lm
Luminaire efficacy	109 lm/W
Temperature	4000 K
Rated life time LED L80/B10	100000 hours
CRI	Ra80
MacAdam	3
Blue light hazard	Risk group 0

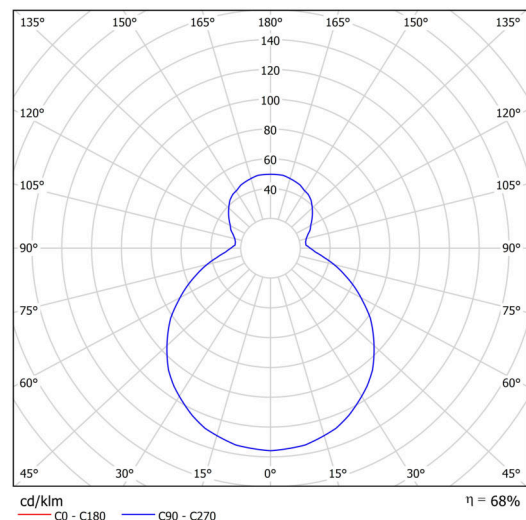

Eulum data for calculation programs are available at

Logistic

EAN	8591728136154
Weight NTTO	7.7 Kg
Weight BTTO	8.2 Kg
Number of cartons	1 pcs
Package volume	0.065 m <sup>3</sup>
Package 1 width	0.515 m
Package 1 length	0.525 m
Package 1 height	0.24 m
Warranty*	60 months

\*The warranty for the batteries is valid for 12 months from the date of purchase.

Installation dimensions:



## Additional assortment:

## Lampshade

Product code	Name	Color	Description	Picture	Drawing
20052	482	white		