



SAGITA V2

LED-1L16E700KNV83/PC53 HF CORR 4K#

WWW.OSMONT.CZ

SAGITA V2

Product code: SAG68694

Type: LED-1L16E700KNV83/PC53 HF CORR 4K#

Short description of the luminaire: White semi-recessed LED light with CORRIDOR function and polycarbonate shade.



Technical

Types of luminaires	Corridor
Mounting type	semi-recessed
Base material	steel
Shade material	opal polycarbonate
Base color	white Ra9003
Shade color	white
Holding the shade	folding system
Mounting location	ceiling/wall
Width	400 mm
Length	400 mm
Height	78 mm
Diameter	ø 400 mm
mounting holes (diameter)	none
Installation wire (diameter)	2xø16mm
Energy Class	D
Impact strength	IK10
Operating temperature	from -20°C to +30°C

Electric

Power consumption	34 W
Ingress Protection	IP44
Socket	LED modul
Sensor	HF
terminal block	snap terminal block
Automatic circuit breaker type B10A	18 pcs
Automatic circuit breaker type B16A	28 pcs
Automatic circuit breaker type C10A	30 pcs
Automatic circuit breaker type C16A	46 pcs

Luminous

Lum. flux of luminaire	3430 lm
Lum. flux of light source	5270 lm
Luminaire efficacy	100 lm/W
Temperature	4000 K
Rated life time LED L80/B10	100000 hours
CRI	Ra80
MacAdam	3
Blue light hazard	Risk group 0

Eulum data for calculation programs are available at www.osmont.cz.

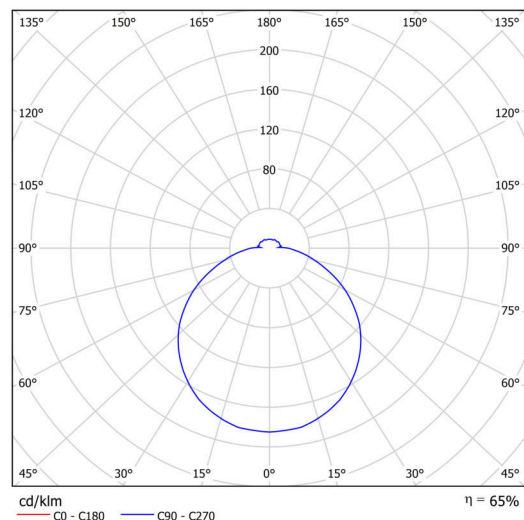
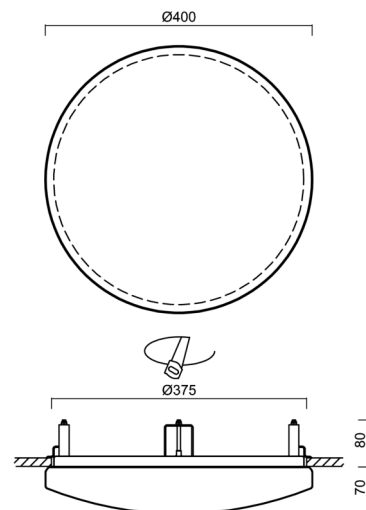

Logistic

EAN	8591728135706
Weight NTTO	2.45 Kg
Weight BTTO	2.85 Kg
Number of cartons	1 pcs
Package volume	0.049 m ³
Package 1 width	0.454 m
Package 1 length	0.454 m
Package 1 height	0.24 m
Warranty*	60 months

*The warranty for the batteries is valid for 12 months from the date of purchase.

Installation dimensions:



Svítidlo nesmí být z horní strany zakryto izolací.
Luminaire must not be covered with insulating matting.



Rozměry dutiny pro vestavné svítidlo [mm]:
Dimensions of cavity for recessed luminaire [mm]:



Additional assortment:

Lampshade

Product code	Name	Color	Description	Picture	Drawing
20554	PC53	white		