



## SADIRA 2

---

LED-1L14E500BD13/PC67 DALI 4K#

[WWW.OSMONT.CZ](http://WWW.OSMONT.CZ)

# SADIRA 2

Product code: SAD60507

Type: LED-1L14E500BD13/PC67 DALI 4K#

Short description of the luminaire: White color | surface-mounted LED light | dimmable DALI | polycarbonate shade

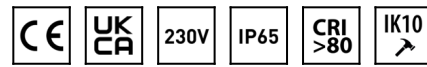

## Technical

Types of luminaires	Dimmable
Mounting type	surface mounted
Base material	polypropylene composite
Shade material	opal polycarbonate
Base color	white Ra9003
Shade color	white
Holding the shade	bayonet
Mounting location	ceiling/wall
Width	296 mm
Length	296 mm
Height	76 mm
Diameter	Ø 296 mm
mounting holes (diameter)	3xØ5mm
Installation wire (diameter)	2xØ16mm
Energy Class	D
Impact strength	IK10
Operating temperature	from -20°C to +30°C

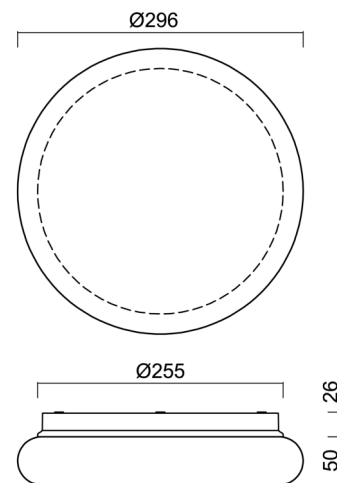

## Electric

Power consumption	13 W
Ingress Protection	IP65
Socket	LED modul
terminal block	snap terminal block
Automatic circuit breaker type B10A	31 pcs
Automatic circuit breaker type B16A	50 pcs
Automatic circuit breaker type C10A	52 pcs
Automatic circuit breaker type C16A	85 pcs

## Luminous

Lum. flux of luminaire	1540 lm
Lum. flux of light source	2080 lm
Luminaire efficacy	118 lm/W
Temperature	4000 K
Rated life time LED L80/B10	100000 hours
CRI	Ra80
MacAdam	3
Blue light hazard	Risk group 0

Eulum data for calculation programs are available at [www.osmont.cz](http://www.osmont.cz).

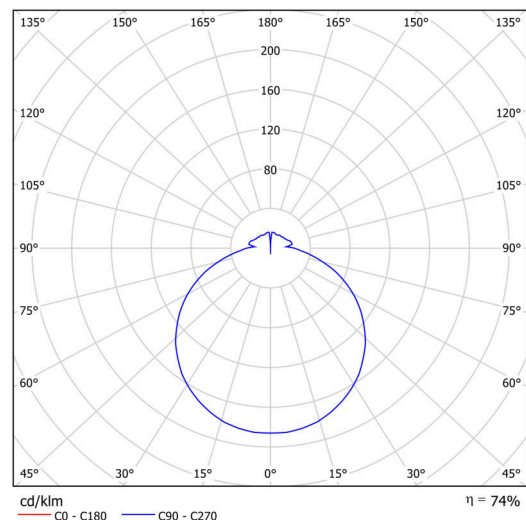

# TECHNICAL SHEET



## Logistic

EAN	8591728089337
Weight NTTO	0.6 Kg
Weight BTTO	0.9 Kg
Warranty*	60 months

\*The warranty for the batteries is valid for 12 months from the date of purchase.

## Installation dimensions:

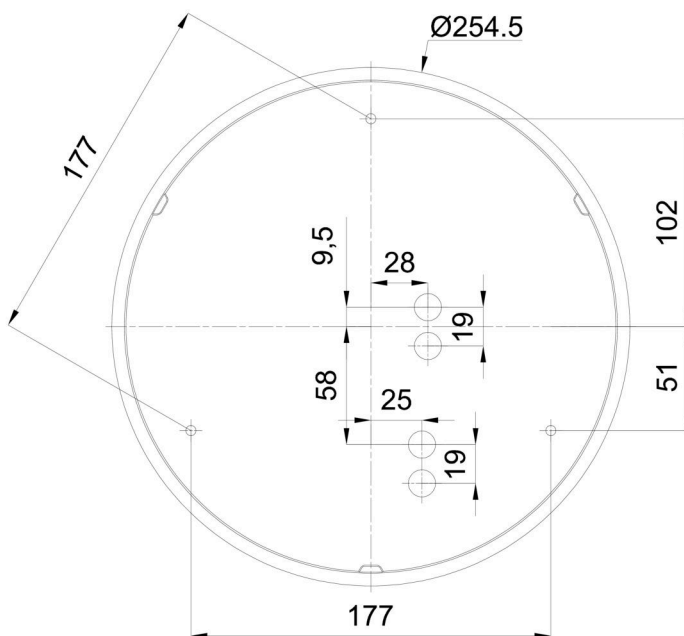

## Additional assortment:

## Lampshade

Product code	Name	Color	Description	Picture	Drawing
20625	PC67	white		