



## SADIRA 2

---

LED-1L14E350BD13/PC67 HF CORR 4K#

[WWW.OSMONT.CZ](http://WWW.OSMONT.CZ)

# SADIRA 2

Product code: SAD60503

Type: LED-1L14E350BD13/PC67 HF CORR 4K#

Short description of the luminaire: White color | surface-mounted LED light | CORRIDOR function (HF+DALI) | polycarbonate shade



## Technical

Types of luminaires	Corridor
Mounting type	surface mounted
Base material	polypropylene composite
Shade material	opal polycarbonate
Base color	white Ral9003
Shade color	white
Holding the shade	bayonet
Mounting location	ceiling/wall
Width	296 mm
Length	296 mm
Height	76 mm
Diameter	ø 296 mm
mounting holes (diameter)	3xø5mm
Installation wire (diameter)	2xø16mm
Energy Class	D
Impact strength	IK10
Operating temperature	from -20°C to +30°C

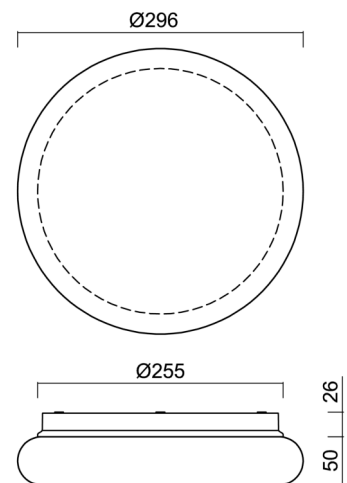

## Electric

Power consumption	9 W
Ingress Protection	IP65
Socket	LED modul
Sensor	HF
terminal block	snap terminal block
Automatic circuit breaker type B10A	21 pcs
Automatic circuit breaker type B16A	35 pcs
Automatic circuit breaker type C10A	35 pcs
Automatic circuit breaker type C16A	58 pcs

## Luminous

Lum. flux of luminaire	1100 lm
Lum. flux of light source	1480 lm
Luminaire efficacy	122 lm/W
Temperature	4000 K
Rated life time LED L80/B10	100000 hours
CRI	Ra80
MacAdam	3
Blue light hazard	Risk group 0

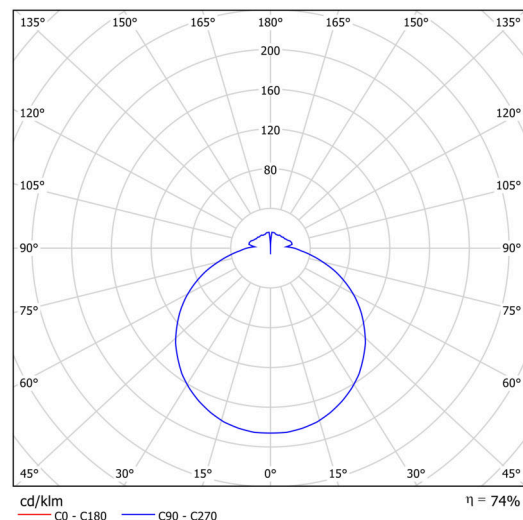

Eulum data for calculation programs are available at [www.osmont.cz](http://www.osmont.cz).

# TECHNICAL SHEET



## Logistic

EAN	8591728089290
Weight NTTO	0.6 Kg
Weight BTTO	0.9 Kg
Warranty*	60 months

\*The warranty for the batteries is valid for 12 months from the date of purchase.

## Installation dimensions:

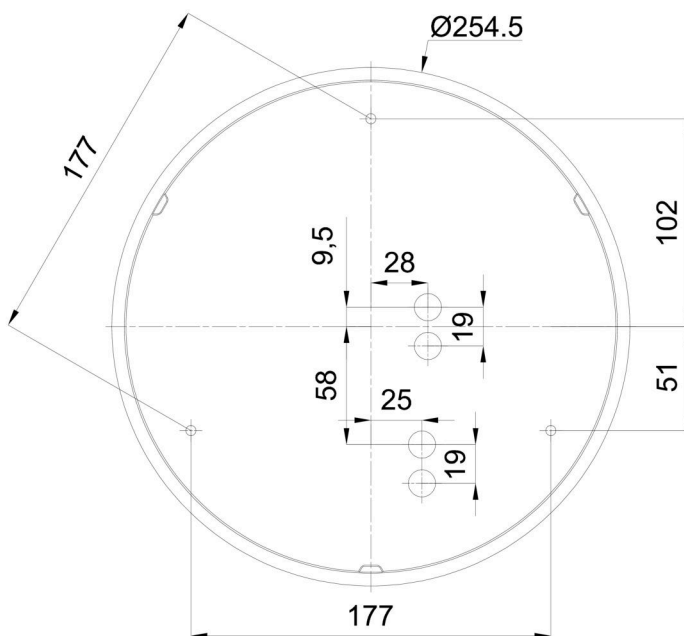

## Additional assortment:

## Lampshade

Product code	Name	Color	Description	Picture	Drawing
20625	PC67	white		