



RANA

LED-1L18E350BTH1/K01 B 4K#

WWW.OSMONT.CZ

RANA

Product code: RAN61942

Type: LED-1L18E350BTH1/K01 B 4K#

Short description of the luminaire: White surface-mounted LED light ON/OFF with TRIPLEX OPAL glass shade.



Technical

Types of luminaires	Classic on/off
Mounting type	surface mounted
Base material	steel
Shade material	three-layer glass TRIPLEX OPAL
Base color	white Ral9003
Shade color	white
Holding the shade	bayonet
Mounting location	ceiling/wall
Width	290 mm
Length	290 mm
Height	110 mm
Diameter	ø 290 mm
mounting holes (diameter)	3xø5mm
Installation wire (diameter)	2xø16mm
Energy Class	D
Impact strength	IK01
Operating temperature	from -20°C to +30°C

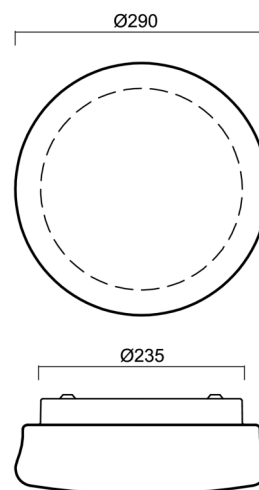

Electric

Power consumption	15 W
Ingress Protection	IP44
Socket	LED modul
terminal block	snap terminal block
Automatic circuit breaker type B10A	72 pcs
Automatic circuit breaker type B16A	116 pcs
Automatic circuit breaker type C10A	72 pcs
Automatic circuit breaker type C16A	116 pcs

Luminous

Lum. flux of luminaire	1830 lm
Lum. flux of light source	2320 lm
Luminaire efficacy	122 lm/W
Temperature	4000 K
Rated life time LED L80/B10	100000 hours
CRI	Ra80
MacAdam	3
Blue light hazard	Risk group 0

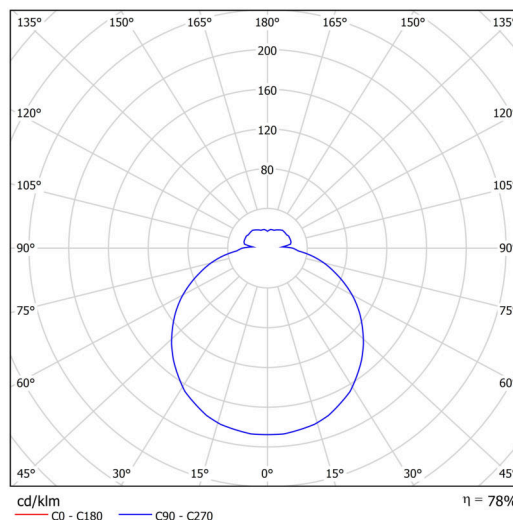

Eulum data for calculation programs are available at www.osmont.cz.

Logistic

EAN	8591728142308
Weight NTTO	1.6 Kg
Weight BTTO	1.7 Kg
Number of cartons	1 pcs
Package volume	0.011 m ³
Package 1 width	0.3 m
Package 1 length	0.3 m
Package 1 height	0.118 m
Warranty*	60 months

*The warranty for the batteries is valid for 12 months from the date of purchase.

Installation dimensions:

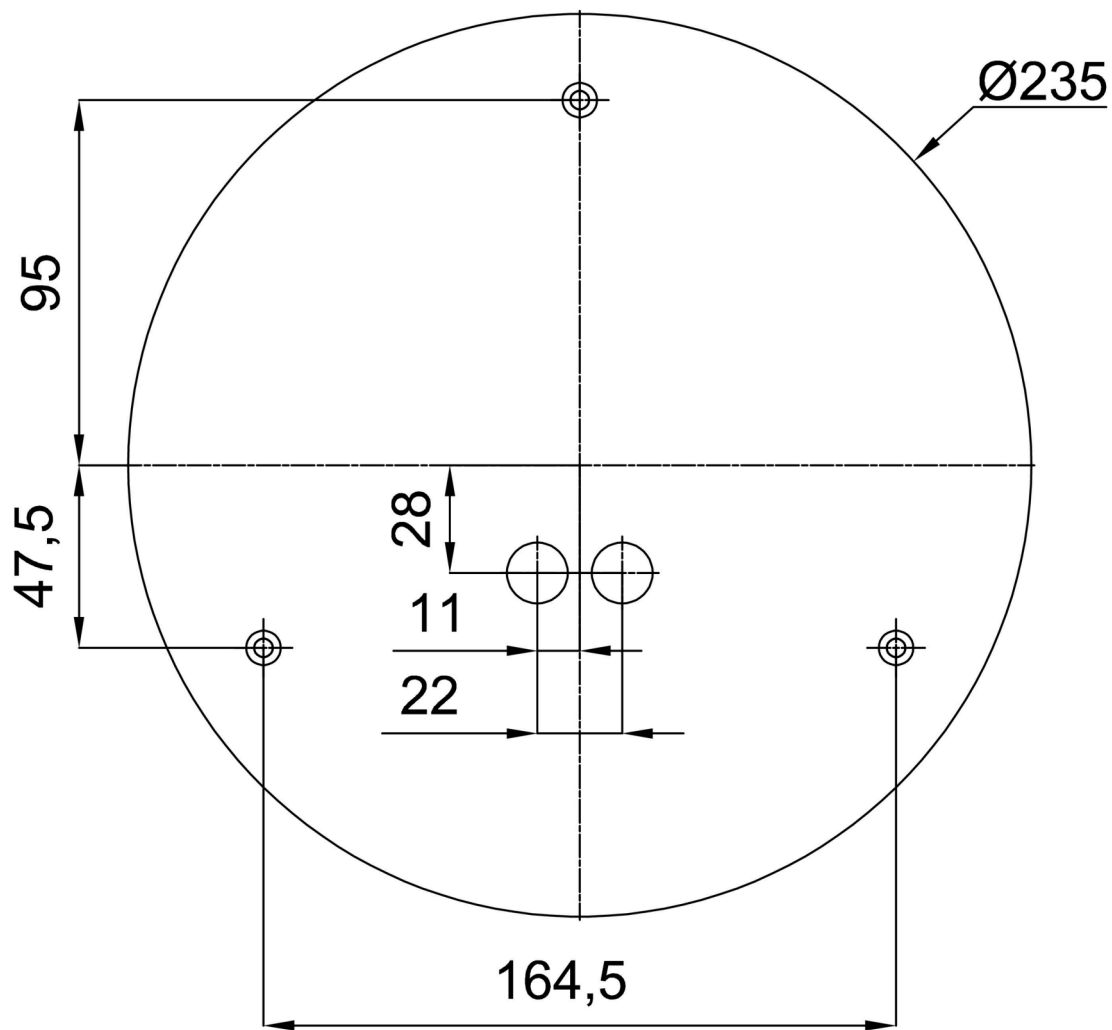

Additional assortment:

Lampshade

Product code	Name	Color	Description	Picture	Drawing
20202	K01	white		