



MIRA

IN-12S6/195/S4 HF*

WWW.OSMONT.CZ

MIRA

Product code: MIR46183

Type: IN-12S6/195/S4 HF*

Short description of the luminaire: White surface-mounted E27 light with sensor with TRIPLEX OPAL glass shade.

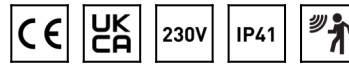

Technical

Types of luminaires	Sensor
Mounting type	surface mounted
Base material	steel
Shade material	three-layer glass TRIPLEX OPAL
Base color	white Ral9003
Shade color	white
Holding the shade	screws
Mounting location	ceiling
Width	350 mm
Length	350 mm
Height	430 mm
Diameter	ø 350 mm
mounting holes (diameter)	2xø5mm
Installation wire (diameter)	1xø14mm
Impact strength	IK01
Operating temperature	from -20°C to +30°C

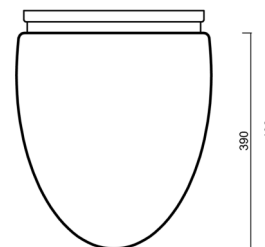
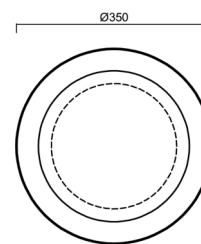

Electric

Voltage type	AC
AC voltage	220 - 240 V
Power consumption	40 W
Ingress Protection	IP41
Socket	E27
Sensor	HF
terminal block	snap terminal block

Luminous

Blue light hazard	Risk group 0
-------------------	--------------

Eulum data for calculation programs are available at www.osmont.cz.

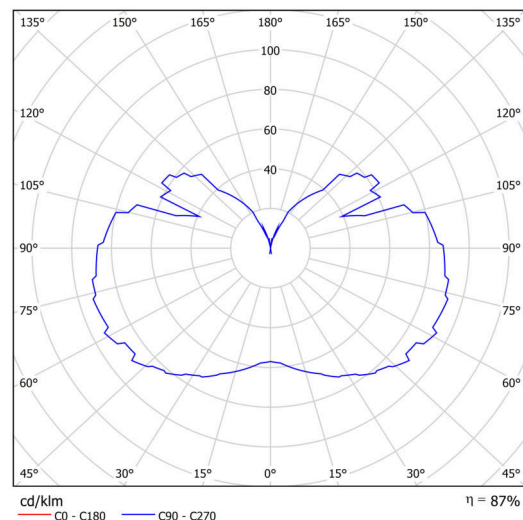

Logistic

EAN	8591728461836
Weight NTTO	4.8 Kg
Weight BTTO	5.6 Kg
Number of cartons	1 pcs
Package volume	0.07 m ³
Package 1 width	0.405 m
Package 1 length	0.405 m
Package 1 height	0.425 m
Warranty*	60 months

*The warranty for the batteries is valid for 12 months from the date of purchase.

Installation dimensions:

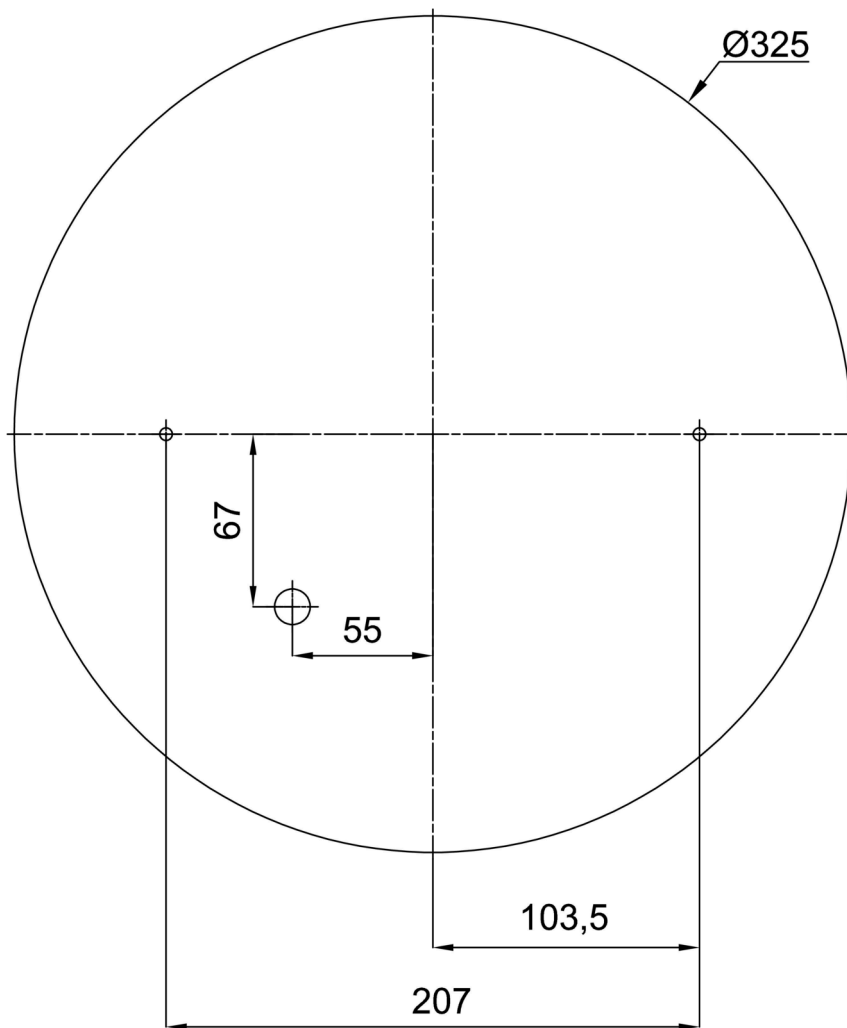

Additional assortment:

Lampshade

Product code	Name	Color	Description	Picture	Drawing
20049	195	white		