

LUKIDA ST2

LED-5L06E450ZST/094/L100 KP B DALI 4K#

WWW.OSMONT.CZ

LUKIDA ST2

Product code: LUK60525

Type: LED-5L06E450ZST/094/L100 KP B DALI 4K#

Short description of the luminaire: White color | pendant LED light | dimmable DALI | TRIPLEX OPAL glass shade with matt surface | decorative collar

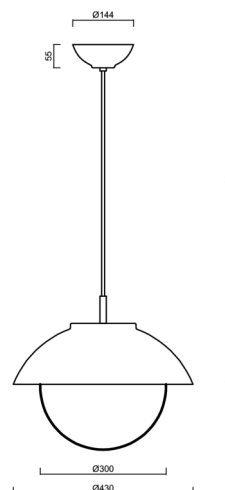

Technical

Types of luminaires	Dimmable
Mounting type	Suspended - textile cable
Base material	steel
Shade material	three-layer glass TRIPLEX OPAL
Base color	white Ral9003
Shade color	white
Holding the shade	bayonet
Mounting location	ceiling
Width	430 mm
Length	430 mm
Height	300 mm
Diameter	ø 430 mm
Hinge length	1000 mm
mounting holes (diameter)	none
Installation wire (diameter)	none
Energy Class	D
Impact strength	IK01
Operating temperature	from -20°C to +30°C

Electric

Power consumption	20 W
Ingress Protection	IP40
Socket	LED modul
terminal block	none
Automatic circuit breaker type B10A	31 pcs
Automatic circuit breaker type B16A	50 pcs
Automatic circuit breaker type C10A	52 pcs
Automatic circuit breaker type C16A	85 pcs

Luminous

Lum. flux of luminaire	2280 lm
Lum. flux of light source	3510 lm
Luminaire efficacy	114 lm/W
Temperature	4000 K
Rated life time LED L80/B10	100000 hours
CRI	Ra80
MacAdam	3
Blue light hazard	Risk group 0

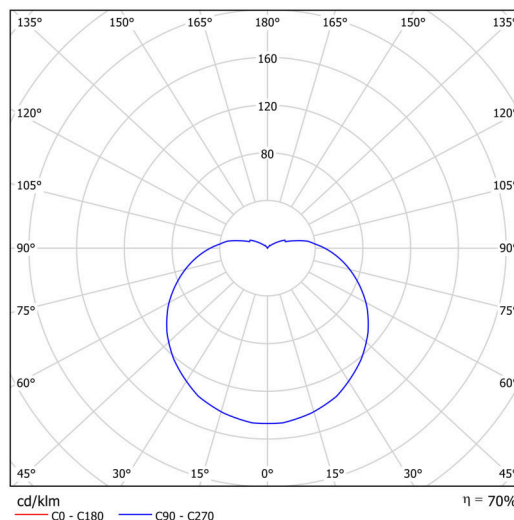

Eulum data for calculation programs are available at

Logistic

EAN	8591728086985
Weight NTTO	5 Kg
Weight BTTO	5.4 Kg
Number of cartons	2 pcs
Package 1 width	0.47 m
Package 1 length	0.46 m
Package 1 height	0.23 m
Warranty*	60 months

*The warranty for the batteries is valid for 12 months from the date of purchase.

Installation dimensions:

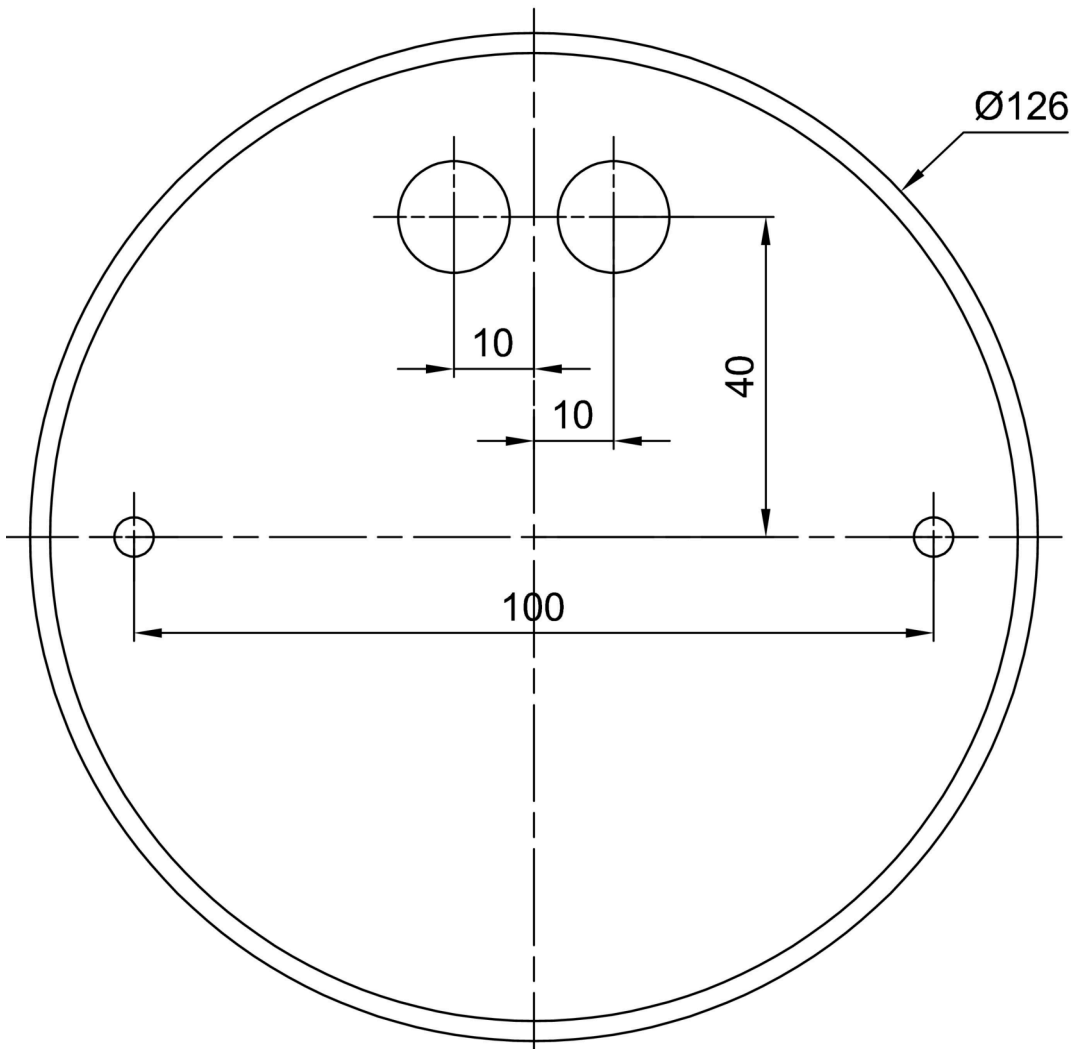

Additional assortment:

Lampshade

Product code	Name	Color	Description	Picture	Drawing
20039	094	white		