



LINA 6

LED-1L15E500K76/039 NK3HST 3K#

WWW.OSMONT.CZ

LINA 6

Product code: LIN67471

Type: LED-1L15E500K76/039 NK3HST 3K#

Short description of the luminaire: White colour | ceiling or wall LED light with emergency backup combined (with Self-test) | TRIPLEX OPAL hand blown glass shade|

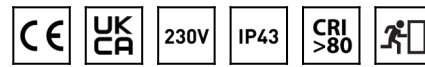

Technical

Types of luminaires	Emergency combined
Mounting type	surface mounted
Base material	steel
Shade material	three-layer glass TRIPLEX OPAL
Base color	white Ral9003
Shade color	white
Holding the shade	folding system
Mounting location	ceiling/wall
Width	380 mm
Length	380 mm
Height	120 mm
mounting holes (diameter)	4xØ5mm
Cable entrance	2xØ16mm
Energy Class	D
Impact strength	IK01
Operating temperature	from 0°C to +30°C

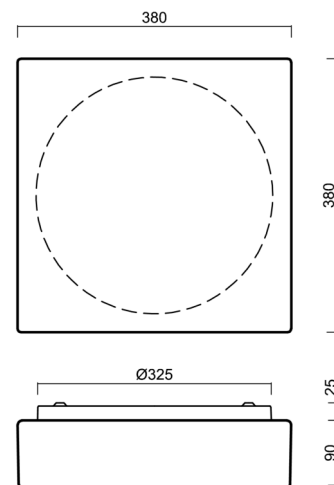

Electric

Power consumption	19 W
Ingress Protection	IP43
Socket	LED modul
Battery type	LiFePO4
Emergency time	3 hours
SELFTEST	yes
terminal block	snap terminal block

Luminous

Lum. flux of luminaire	2040 lm
Lum. flux of light source	3000 lm
Lum. flux of light source in emergency mode	200 lm
Temperature	3000 K
Rated life time LED L80/B10	100000 hours
CRI	Ra80
MacAdam	3
Blue light hazard	Risk group 0

Eulum data for calculation programs are available at www.osmont.cz.

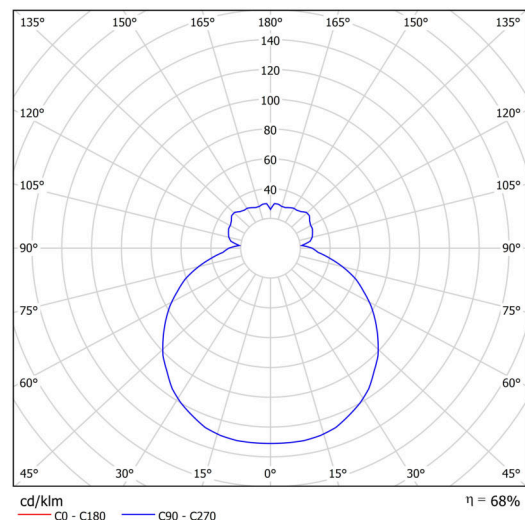

Logistic

EAN	8591728158729
Weight NTTO	4.8 Kg
Weight BTTO	5.2 Kg
Number of cartons	1 pcs
Package volume	0.021 m ³
Package 1 width	0.39 m
Package 1 length	0.41 m
Package 1 height	0.13 m
Warranty*	60 months

*The warranty for the batteries is valid for 12 months from the date of purchase.

Installation dimensions:

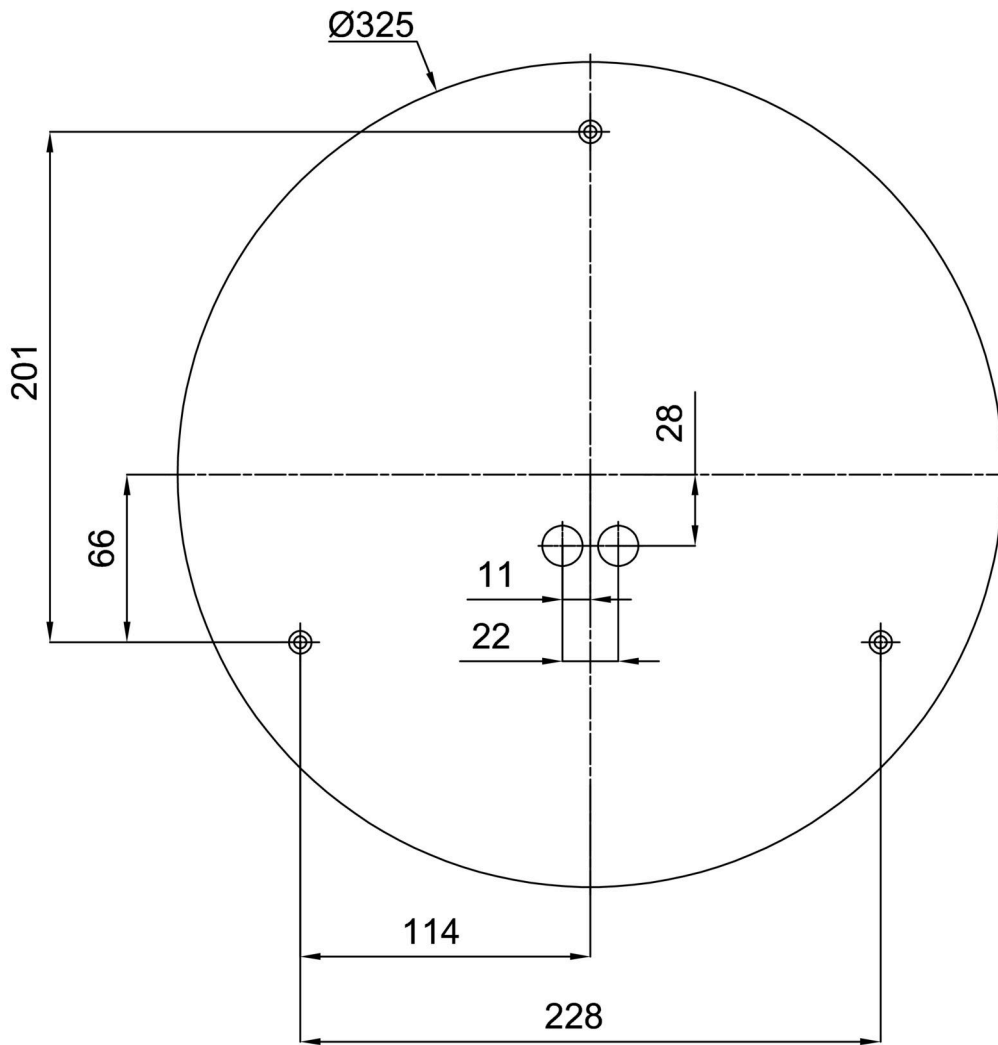

Additional assortment:

Lampshade

Product code	Name	Color	Description	Picture	Drawing
20053	039	white	příslušenství	