



KUMA LE3

LED-5L76E1050ZLE/437/L100 C DALI 4K##

WWW.OSMONT.CZ

KUMA LE3

Product code: KUM70988

Type: LED-5L76E1050ZLE/437/L100 C DALI 4K##

Short description of the luminaire: Black pendant LED light DALI with TRIPLEX OPAL glass shade



Technical

Types of luminaires	Dimmable
Mounting type	Suspended - SELV wire (cableless)
Base material	steel
Shade material	three-layer glass TRIPLEX OPAL
Base color	black Ral9005
Shade color	white
Holding the shade	folding system
Mounting location	ceiling
Width	150 mm
Length	150 mm
Height	535 mm
Diameter	ø 150 mm
Hinge length	1000 mm
mounting holes (diameter)	2xø5mm
Installation wire (diameter)	1xø14mm
Energy Class	D
Impact strength	IK01
Operating temperature	from -20°C to +30°C

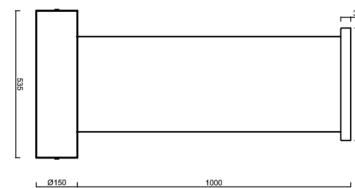

Electric

Power consumption	31 W
Ingress Protection	IP20
Socket	LED modul
terminal block	snap terminal block
Automatic circuit breaker type B10A	31 pcs
Automatic circuit breaker type B16A	50 pcs
Automatic circuit breaker type C10A	52 pcs
Automatic circuit breaker type C16A	85 pcs

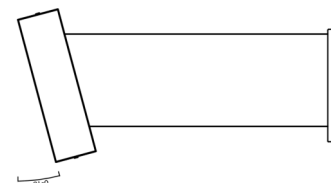

Luminous

Lum. flux of luminaire	4740 lm
Lum. flux of light source	5450 lm
Luminaire efficacy	152 lm/W
Temperature	4000 K
Rated life time LED L80/B10	100000 hours
CRI	Ra80
MacAdam	3
Blue light hazard	Risk group 0

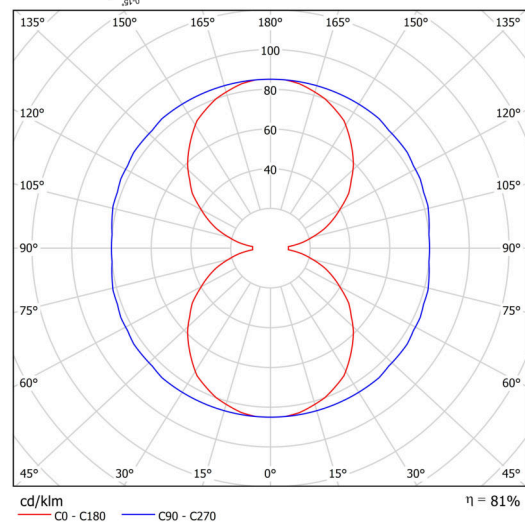

Eulum data for calculation programs are available at

Logistic

EAN	8591728138806
Weight NTTO	3.9 Kg
Weight BTTO	4.1 Kg
Number of cartons	1 pcs
Warranty*	60 months

*The warranty for the batteries is valid for 12 months from the date of purchase.

Installation dimensions:

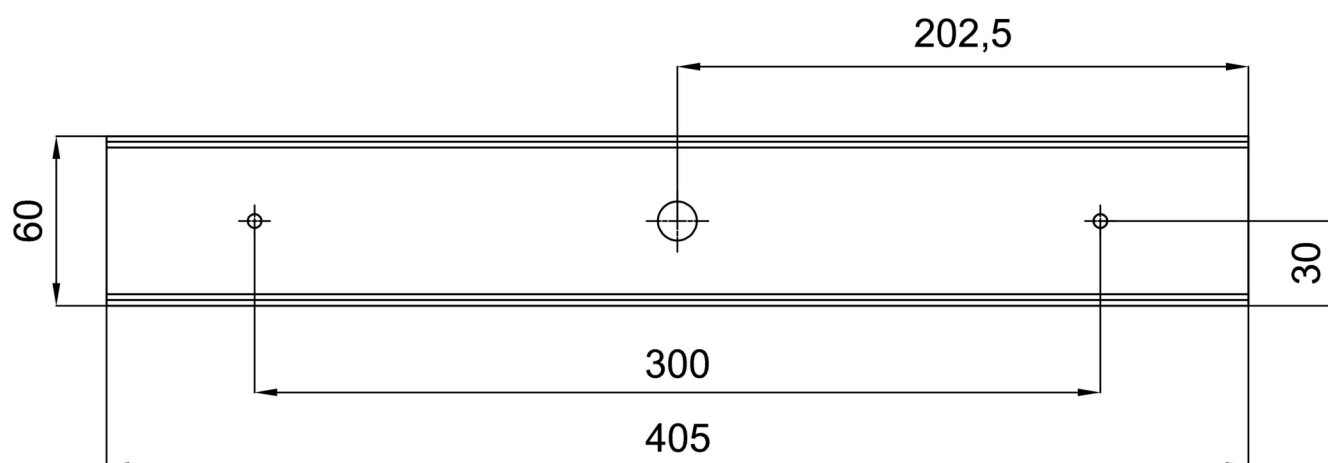

Additional assortment:

Lampshade

Product code	Name	Color	Description	Picture	Drawing
20139	437	white		